

GMK7550

Product Guide

ASME B30.5
Imperial 85%



Features

- 450 t (550 USt) capacity
- 60 m (197 ft) five-section boom
- 25 m - 79 m (82 ft - 259 ft) lattice luffing jib
- 120 t (264,500 lb) counterweight with hydraulic installation/removal system
- MegaWingLift™
- Allison 4800 SP transmission

GROVE GMK7550

The GMK7550, offers a 550 USt maximum capacity on a seven-axle carrier with a stowing crane cab for highway travel. The optional MegaWingLift attachment increases capacity throughout the working radius.

Features

> MEGATRAK™

The MEGATRAK™ suspension system is the best off-road driveline available on the market today. The system's versatility and performance allows the GMK7550 to operate as a true all-terrain crane. The MEGATRAK™ independent suspension and all-wheel steer system allows wheels to remain on the ground at all times so stresses and weight are not continually transferred between axles. MEGATRAK™ provides true ground clearance where others just raise the chassis.

Other benefits of the MEGATRAK™ system are:

- A reliable suspension system
- Excellent job site maneuverability with all-wheel steering
- Commonality among almost all models
- A driveline that remains aligned at all times
- A steering linkage system that is protected against damage
- Constant tire contact for equal tire wear
- Reduced maintenance



> TWIN-LOCK™

Boom pinning mechanism automatically pins the sections in position using two horizontal pins.

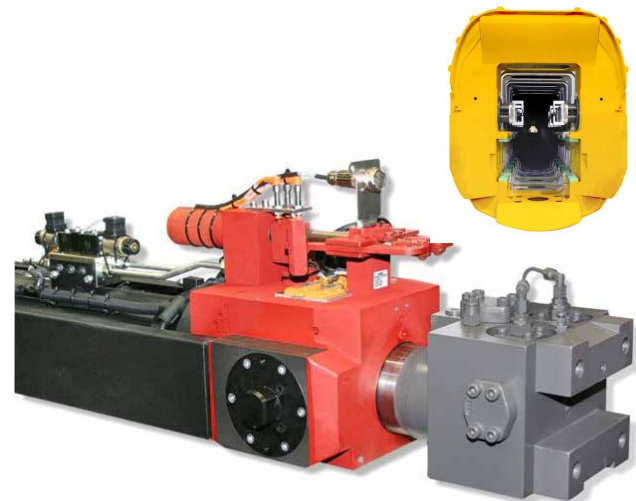

> ECOS and EKS 5

Electronic Crane Operating System - ECOS enables control of the entire crane's principle operations. Simple programming eases lift planning and a supply of essential information allows full concentration on the lift itself.

The EKS 5 monitors the lifting conditions of the crane at all times and provides a full graphic display, rear lighting, graphic of boom telescoping percentage, and load charts.



> CraneSTAR®

CraneSTAR is an exclusive and innovative crane asset management system

that helps improve your profitability and reduce costs by remotely monitoring critical crane data.

Visit www.cranestar.com for more information.



Contents

Specifications.....	4
Dimensions.....	7
Counterweight.....	12
Travel proposals	13
Working range/load charts main boom	15
Working range/load charts luffing jib.....	20
Working range/load charts fixed jib	41
Working range/load charts heavy duty jib	49
Symbols glossary.....	57

Specifications

Superstructure



Boom

16 m - 60 m (53 ft - 197 ft) five-section, full power boom with patented TWIN-LOCK™ boom pinning system. Maximum tip height: 63 m (207 ft).



Boom elevation

Two lift cylinders with safety valves provide boom angles from -1.2° to +82°.



*Lattice jib

Luffing jib is a lattice design with lengths of 25 m - 79 m (82 ft - 259 ft) in sections of 6,2 m (20 ft) and 12,2 m (40 ft). The luffing jib converts to a fixed offset lattice jib providing lengths of 12 m - 70 m (39 ft - 230 ft) offsettable at 3° and 25°.



Load moment and anti-two block system

Graphic display load moment and anti-two block system with audio/visual warning and control lever lockout. These systems provide electronic display of boom angle, length, radius, tip height, relative load moment, maximum permissible load, load indication and warning of impending two-block condition.



Cab

All aluminum construction cab is tiltable (approximately 20°) and includes safety glass and adjustable operator's seat. Other features include engine independent hot water heater including 24 hour timer, air conditioning, armrest integrated crane controls, and ergonomically arranged instrumentation. Cab hydraulically stows to the rear of the superstructure for highway travel.



Swing

Three axial piston fixed displacement motors provide swing speed of 0 - 1.1 RPM thru planetary gear box. Also provided is a spring applied, hydraulically released automatic swing brake with foot operated release for free swing.



Counterweight

120 t (264,500 lb) consisting of various sections with hydraulic installation/removal system (see counterweight configuration on page 12).



Engine

Cummins QSX15, six cylinder, turbo charged diesel, 447 kW (600 hp) at 2100 rpm. Max torque: 2779 Nm (2,050 ft/lb) at 1400 rpm.
Engine emission: EU Stage IV, CARB, U.S. EPA Tier 4 Final (non-road)



Fuel tank capacity

300 L (79 gal).



Hydraulic system

Five separate circuits, Three axial piston variable displacement pumps with electronic power limiting control, 1 axial piston variable displacement pump for slewing and 1 fixed displacement pump for auxiliary gears. Standard thermostatically controlled oil coolers keep oil at optimum operating temperature. Tank capacity: 1570 L (415 gal)



Control system

Full electronic control of all crane movements is accomplished using electrical control levers with automatic reset to zero. Controls are integrated with the LMI and engine management system by CAN-BUS.



Electrical system

24 V system with three-phase alternator 28 V/100 A
2 batteries 12 V/170 Ah.

Specifications

Superstructure continued



Hoist

Main and auxiliary hoist are powered by axial piston variable displacement motor with planetary gear and brake. “Thumb-thumper” hoist drum rotation indicator alerts operator of hoist movement.

	Main	Auxiliary	Auxiliary
Line length	460 m (1509 ft)	690 m (2264 ft)	
Rope diameter	24 mm	24 mm	
Line speed	130 m/min (427 fpm)	130 m/min (427 fpm)	
Line pull	110 kN (24,729 lb)	104 kN (23,380 lb)	

Hoist cameras and lights included.

*Optional hookblocks

Lifting capacity	Sheaves	Weight	Possible load with the crane*
320 t (353 USt)	11	3500 kg (7716 lb)	231 t / 277 t* (255 USt / 305 USt*)
250 t (275 USt)	9	3000 kg (6614 lb)	231 t (255 USt)
200 t (220 USt)	7	2400 kg (5291 lb)	184 t (203 USt)
160 t (176 USt)	5	1800 kg (3669 lb)	136 t (150 USt)
100 t (110 USt)	3	1300 kg (2866 lb)	88 t (97 USt)
40 t** (44 USt)	1	850 kg (1874 lb)	38 t (42 USt)
16 t*** (18 USt)	H/B	450 kg (992 lb)	12,5 t (13.8 USt)

* Requires additional boom nose sheave

** Required for overhaul of single part line with boom/jib lengths in excess of 99,4 m (326 ft)

*** Overhaul weight designed for a maximum of 99,4 m (326 ft) boom/jib lengths

*Optional equipment

- ▣ Second spotlight on superstructure cab
- ▣ Stereo/CD player
- ▣ Lift enhancement system (MegaWingLift™)
- ▣ Additional 40 t (88,200 lb) counterweight for MegaWingLift™
- ▣ Worklights on boom base section
- ▣ Boom position indicator lights
- ▣ Hook blocks
- ▣ Adapter for heavy duty jib
- ▣ 360° positive swing lock

Carrier



Chassis

Special seven-axle carrier, welded torsion resistant frame is fabricated from high-strength steel.



Outrigger system

Hydraulic two-stage outrigger beams are extended by a single hydraulic cylinder and two cables. Outriggers can adjust to two positions:

Fully extended (100%) - 8,9 m (29.2 ft)
Partially extended (50%) - 6,1 m (20 ft)

Four 810 mm x 810 mm (32 in x 32 in), self stowing, steel outrigger pads provide rigid lifting base. Outrigger controls are located on both sides of the carrier. Electronic level indicators with automatic levelling system. Outrigger pad load indication through ECOS and carrier controls. Includes outrigger monitoring system.



Engine

Cummins QSB6.7, six cylinder, turbo charged diesel, 224 kW (300 hp) at 2500 rpm. Max torque: 1044 Nm (770 ft/lb) at 1500 rpm.

Engine emission: EU Stage IV, CARB, U.S. EPA Tier 4 Final (non-road).



Fuel tank capacity

500 L (132 gal).

Specifications

Carrier continued



Transmission

Allison automatic 4800 SP-R, seven forward and one reverse speed. Transfer case with two speeds and inter-axle differential lock. Hydraulic transmission retarder.



Drive/steer

14x6x14



Axles

Seven axles. 1, 4 and 5 are drive/steer. Axles 2, 3, 6 and 7 are steer only.



Suspension

GMK7550 features the Grove exclusive MEGATRAK™ suspension. This revolutionary design features an independent hydroneumatic system with hydraulic lockout acting on all wheels. The suspension can be raised 170 mm (6 - 1/2 in) or lowered 130 mm (5 in) both longitudinally and transversely and features an automatic leveling system for on-highway travel.



Tires

14 tires 445/95 R25 (16.00 R25)
(vehicle width: 3,00 m [9.8 ft])



Steering

Dual circuit steering system is hydraulic power assisted with emergency steering pump. Axles 1, 2, 3, 6 and 7 steer on highway. Separate steering of the 4th, 5th, 6th and 7th axles for all wheel steer and crab-steer, controlled by an electric rocker switch.



Brakes

A dual circuit air system operates on all wheels with a spring-applied, air released parking brake acting on axles 2, 4, 5 and 7. An air dryer is fitted to remove moisture from the air system. Standard engine compression brake and transmission retarder.



Cab

Two-man, aluminum construction driver's cab includes the following features: safety glass; driver seat with pneumatic suspension, engine-dependent hot water heater and air conditioning. Complete instrumentation and driving controls.



Electrical system

24 V system with three-phase alternator 28 V/100 A, 2 batteries 12 V/170 Ah.



Maximum speed

85 km/h (53 mph) with 20.5 R25 tires.



Gradeability (theoretical)

32% with 20.5 R25 tires (14x6x14)
50% with 20.5 R25 tires (14x8x14)

Miscellaneous standard equipment

Boom removal kit; trailing boom kit (less dolly), additional hydraulic oil cooler; removable rear outrigger box; tool kit; fire extinguisher; radio/cd player in carrier cab, CraneSTAR asset management system.

*Optional equipment

- ▶ 14 x 8 x 14 (1,2,4 and 5 are drive/steer)
- ▶ Engine-independent hot water heater, with engine pre-heater
- ▶ 14 tires, 385/95 R25 (14.00 R25).
(vehicle width 3,00 m [9.8 ft])
- ▶ 14 tires, 525/80 R25 (20.5 R25).
(vehicle width 3,1 m [10.2 ft])
- ▶ Aluminum rims
- ▶ Auxiliary axle, pinned when rear outrigger box is removed
- ▶ Hinged bunk bed
- ▶ Working range limiter
- ▶ Reversing camera system
- ▶ Engine shutdown valves (for both engines)

Dimensions

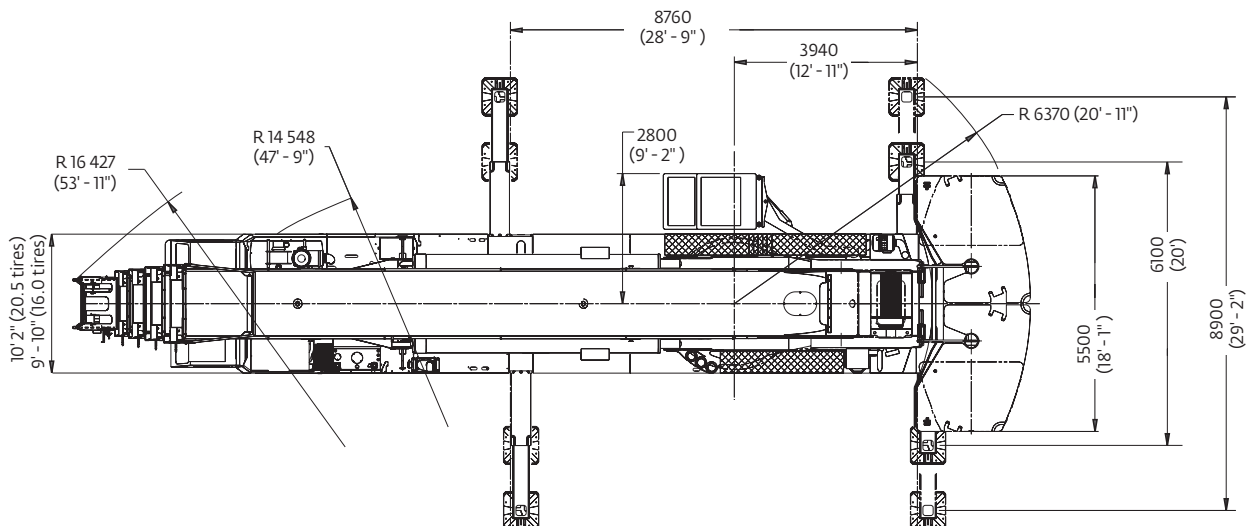
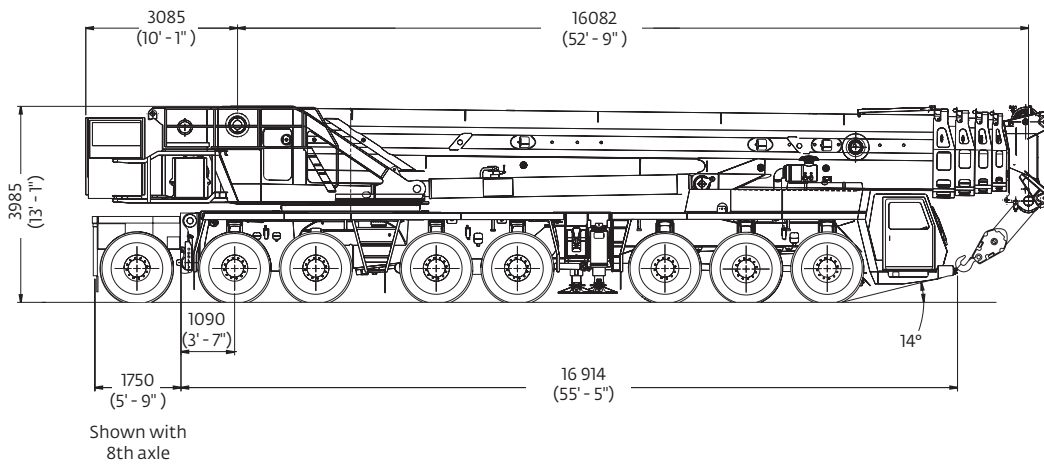
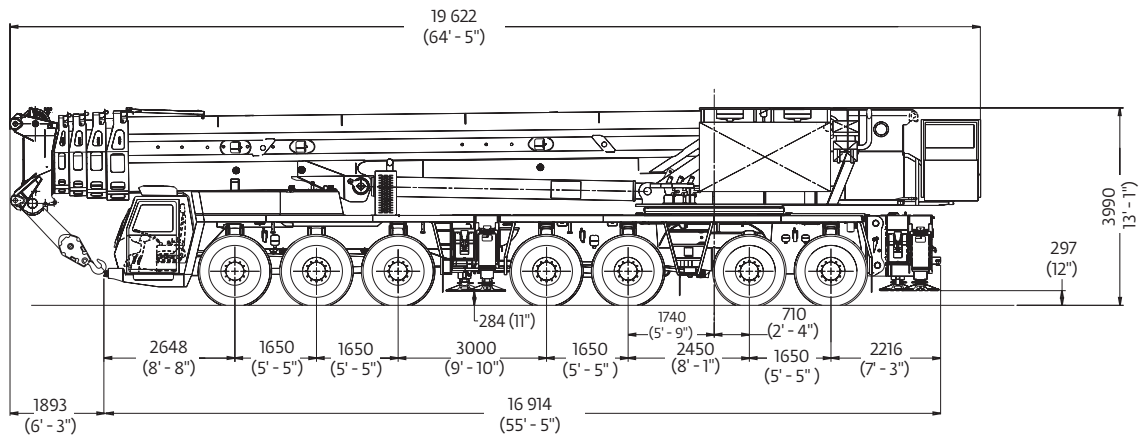

Dimensions

Luffing jib combinations

Without angle offset

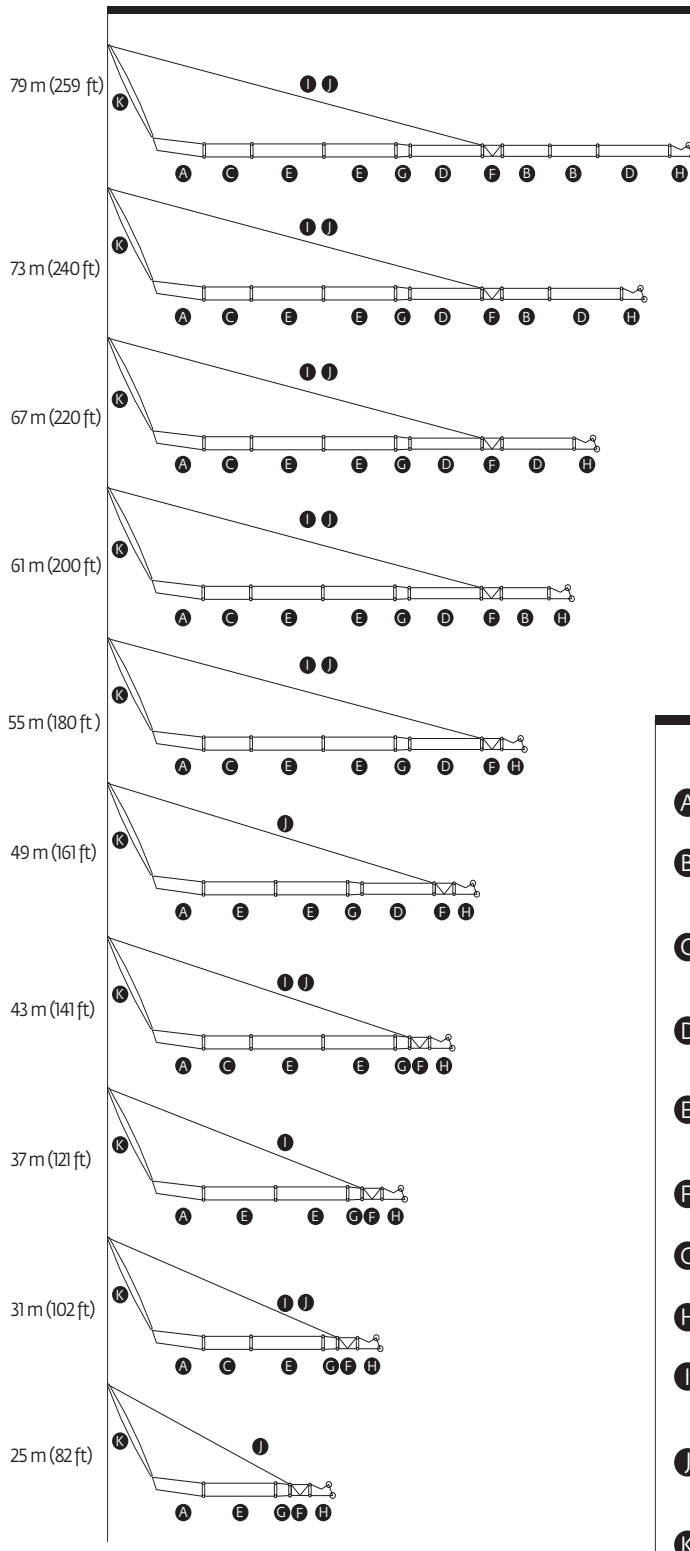

Description	Length x width x height m (ft)	Weight in kg (lb)
A Foot Section	8.80 x 1.80 x 2.50 (28.87 x 5.90 x 8.20)	3700 (8160)
B Short intermediate sections, small cross-section, each	6.20 x 1.50 x 1.50 (20.34 x 4.91 x 4.91)	900 (1985)
C Short intermediate sections, large cross-section, each	6.20 x 1.80 x 1.90 (20.34 x 5.90 x 6.23)	1000 (2205)
D Long intermediate sections, small cross-section, each	12.20 x 1.50 x 1.50 (40.03 x 4.91 x 4.91)	1600 (3530)
E Long intermediate sections, large cross-section, each	12.20 x 1.80 x 1.90 (40.03 x 5.90 x 6.23)	1600 (3530)
F Angle piece	3.70 x 1.50 x 1.80 (12.14 x 4.91 x 5.90)	1600 (3530)
G Reducing piece	1.20 x 1.80 x 1.90 (3.94 x 5.90 x 6.23)	500 (1105)
H Head piece	3.20 x 1.50 x 2.10 (10.50 x 4.91 x 6.89)	1200 (2650)
I Rear pendant link for short intermediate section	6.20 x 0.20 x 0.20 (20.34 x 0.70 x 0.70)	200 (440)
J Rear pendant link for long intermediate section	12.20 x 0.20 x 0.20 (40.03 x 0.70 x 0.70)	400 (880)
K Luffing control arm with fall-back guard strut	12.20 x 2.10 x 1.80 (40.03 x 6.89 x 5.90)	3200 (*7055)

*Individual weight of rear pendant link: 360 kg (795 lb)

Dimensions

Lattice boom extension combinations

Without angle offset

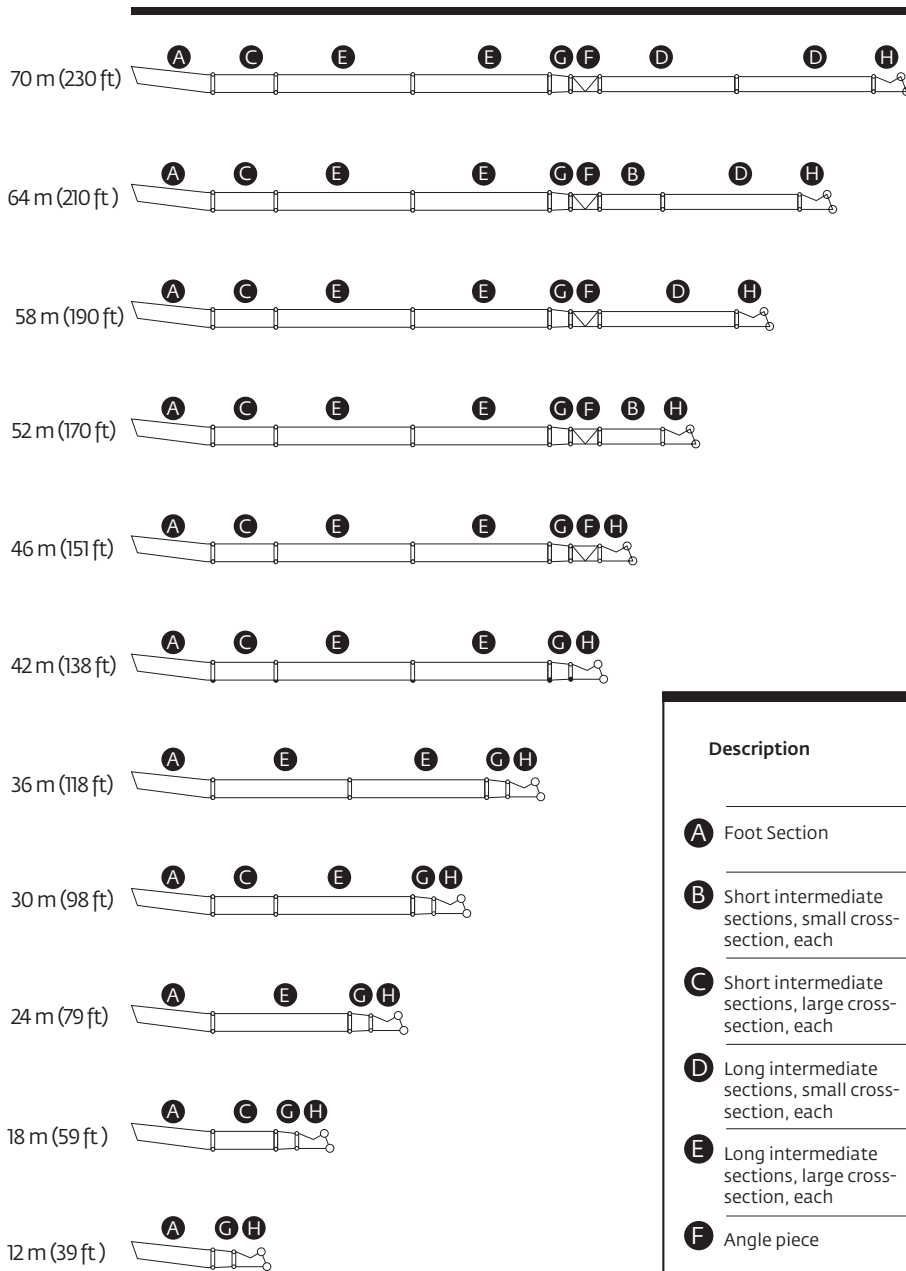

Description	Length x width x height m (ft)	Weight in kg (lb)
A Foot Section	8.80 x 1.80 x 2.50 (28.87 x 5.90 x 8.20)	3700 (8160)
B Short intermediate sections, small cross-section, each	6.20 x 1.50 x 1.50 (20.34 x 4.91 x 4.91)	900 (1985)
C Short intermediate sections, large cross-section, each	6.20 x 1.80 x 1.90 (20.34 x 5.90 x 6.23)	1000 (2205)
D Long intermediate sections, small cross-section, each	12.20 x 1.50 x 1.50 (40.03 x 4.91 x 4.91)	1600 (3530)
E Long intermediate sections, large cross-section, each	12.20 x 1.80 x 1.90 (40.03 x 5.90 x 6.23)	1600 (3530)
F Angle piece	3.70 x 1.50 x 1.80 (12.14 x 4.91 x 5.90)	1600 (3530)
G Reducing piece	1.20 x 1.80 x 1.90 (3.94 x 5.90 x 6.23)	500 (1105)
H Head piece	3.20 x 1.50 x 2.10 (10.50 x 4.91 x 6.89)	1200 (2650)

Dimensions

Aerial rigging of jib

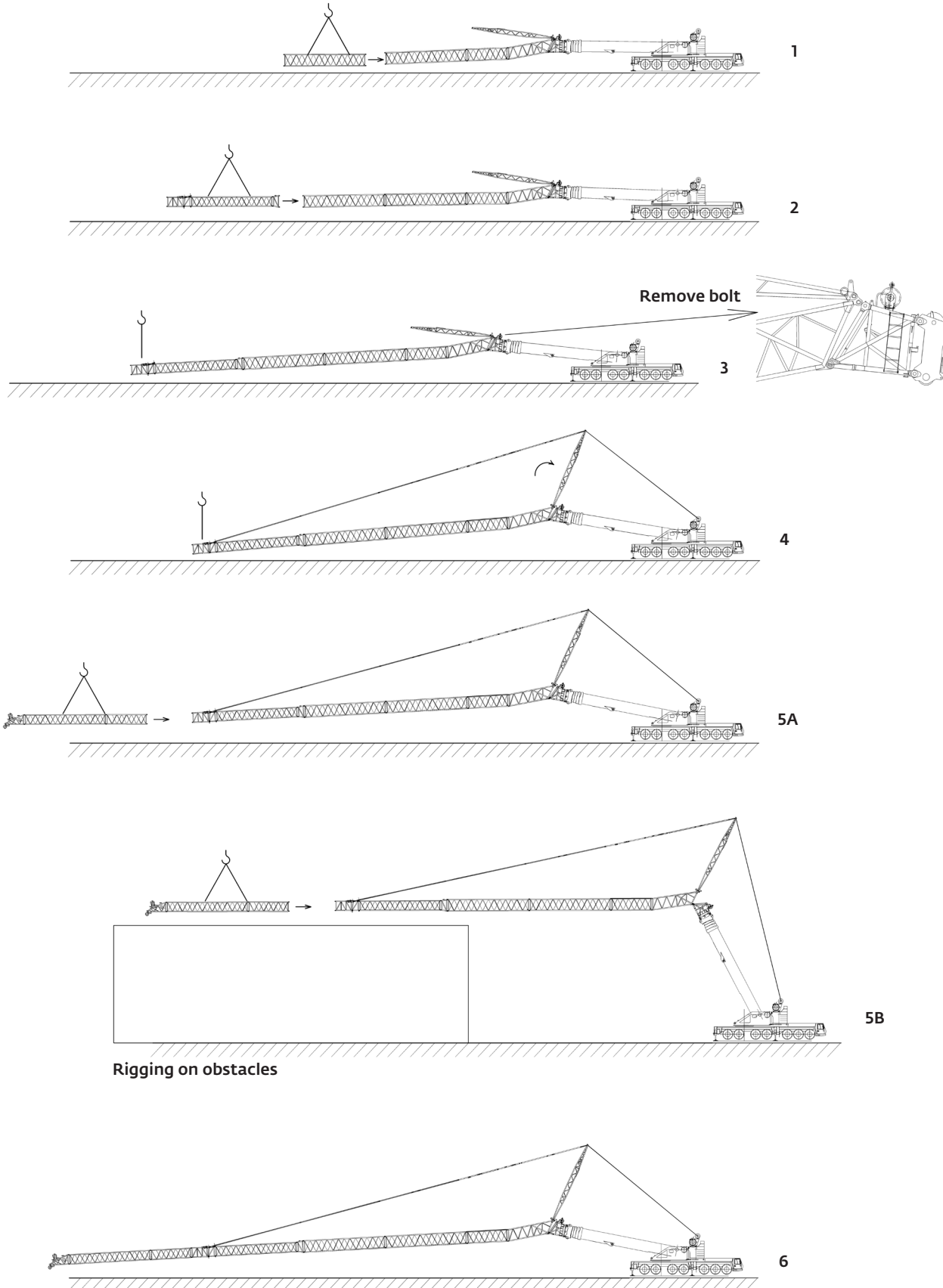

Dimensions

Aerial rigging of jib

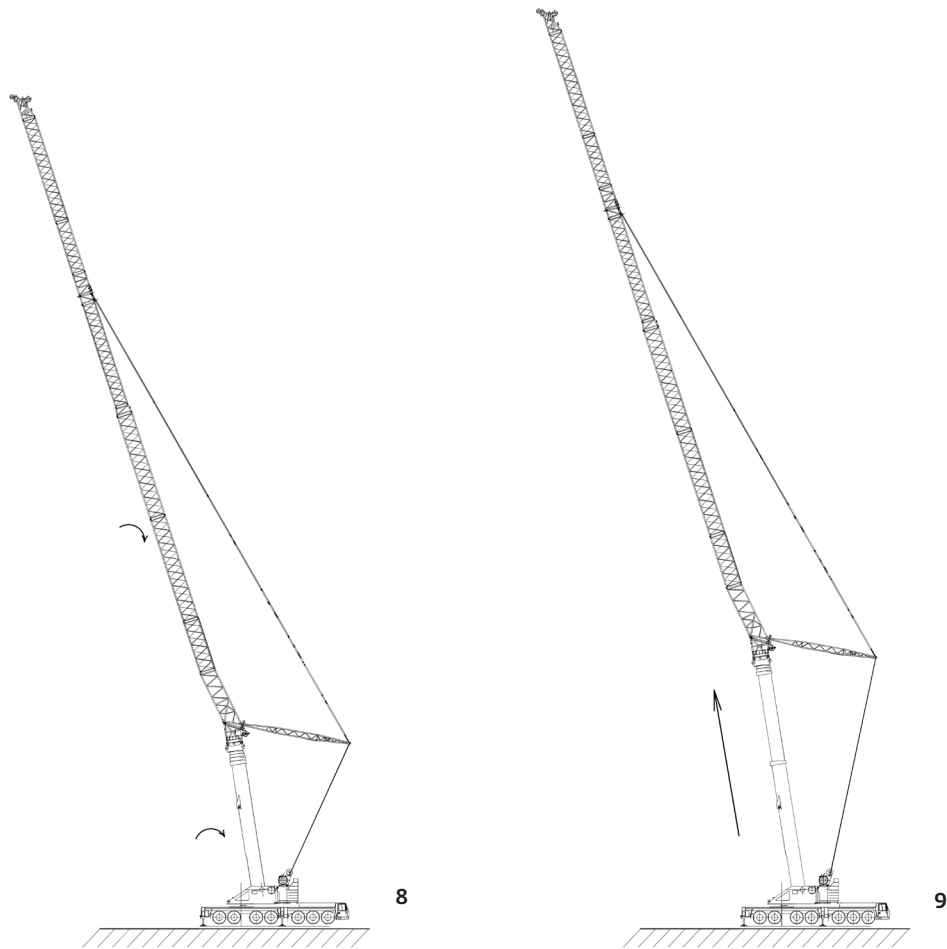
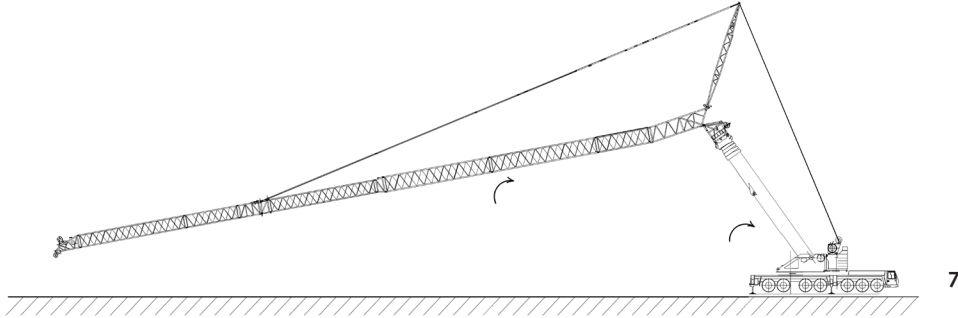

Counterweight

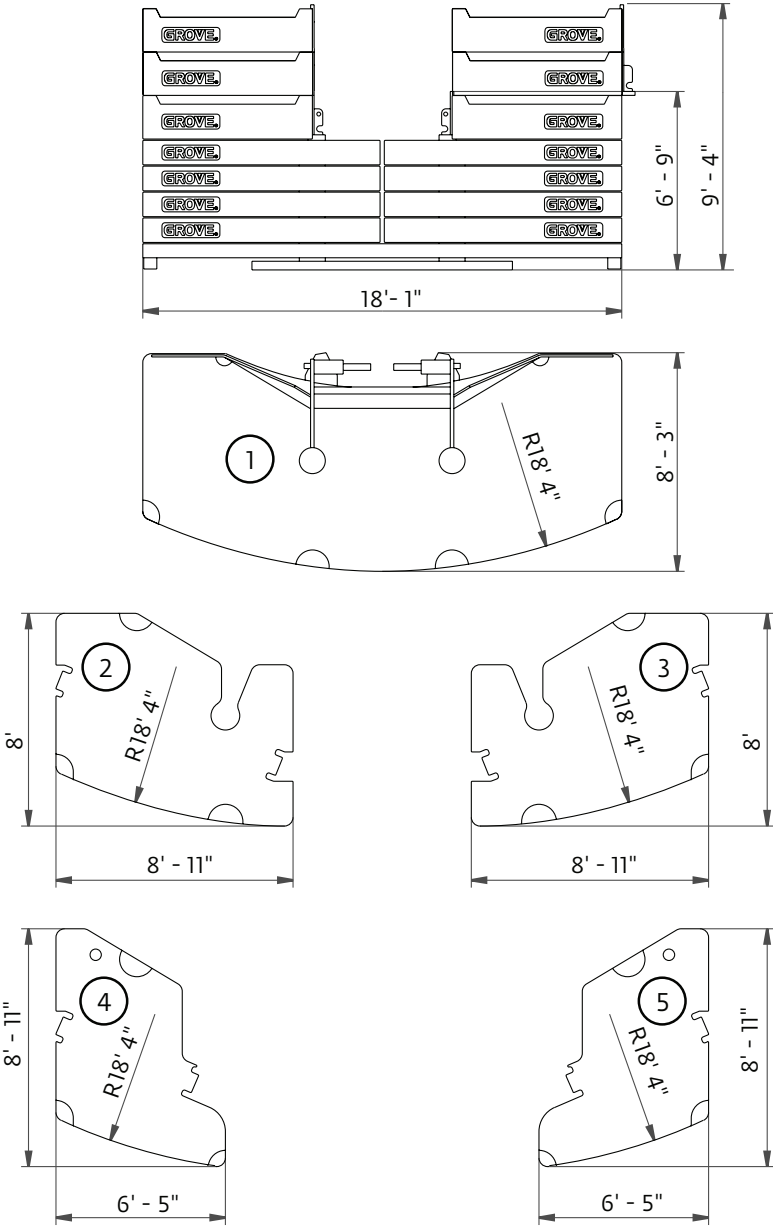

	① 20 t (44,000 lb)	② 10 t (22,000 lb)	③ 10 t (22,000 lb)	④ 10 t (22,000 lb)	⑤ 10 t (22,000 lb)
20,0 t (44,000 lb)	x				
40,0 t (88,100 lb)	x	x	x		
60,0 t (132,200 lb)	x	2 x	2 x		
80,0 t (176,000 lb)	x	3 x	3 x		
100,0 t (220,400 lb)	x	4 x	4 x		
120,0 t (264,500 lb)	x	4 x	4 x	x	x
140,0 t (308,600 lb)	x	4 x	4 x	2 x	2 x
160,0 t (352,700 lb)	x	4 x	4 x	3 x	3 x

Travel proposals

Trailing boom dolly with 8th axle

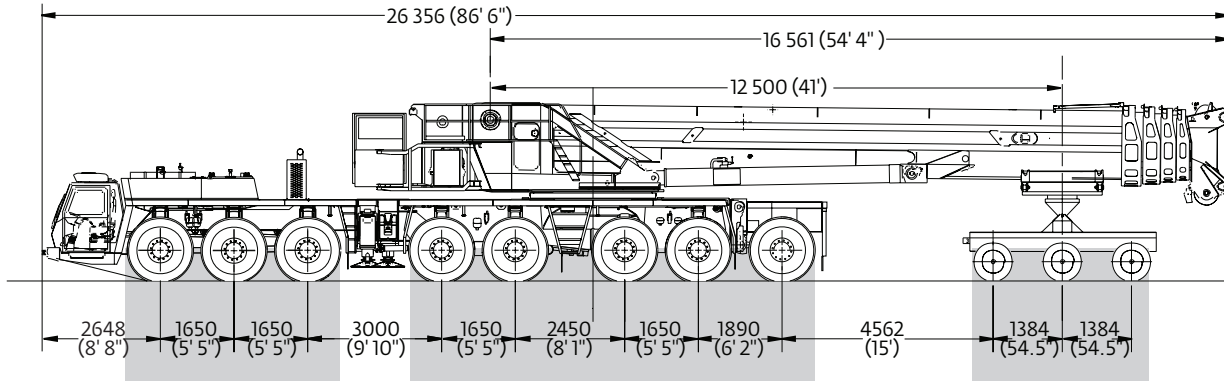

	Axles 1 - 3	Axles 4 - 8	Dolly	Total GVW
Boom in dolly over rear, rear outrigger box removed, 8th axle installed	26 254 kg (57,879 lb)	38 388 kg (84,631 lb)	26 822 kg (59,132 lb)	91 464 kg (201,642 lb)

Unit equipped with:

- 20.5 tires on aluminum rims - axles 1 through 8
- Operator, 75 kg (165 lb)
- Welded on MEGAWINGLIFT hardware
- Dolly weight: 3900 kg (8600 lb)

Allow 3% variation in weight due to manufacturing tolerances

Boom removed, superstructure over rear

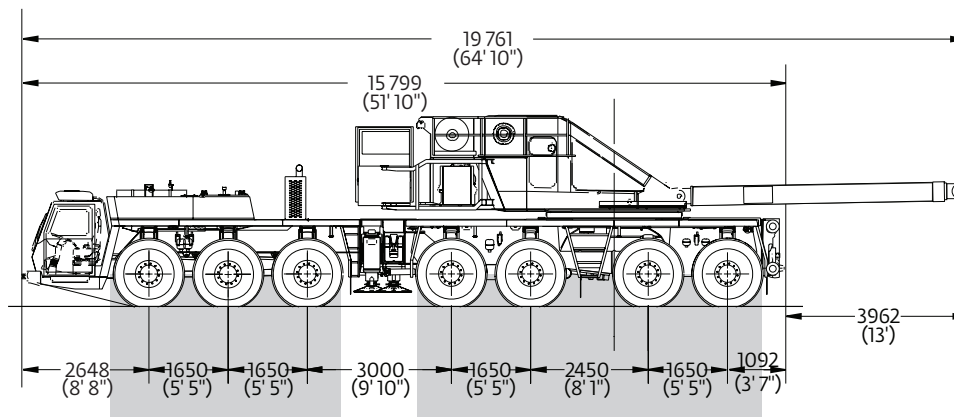

	Axles 1 - 3	Axles 4 - 7	Total GVW
Boom removed, superstructure over rear	16 717 kg (36,855 lb)	34 879 kg (76,895 lb)	51 597 kg (113,750 lb)

Unit equipped with:

- Rear outrigger box removed
- 20.5 tires on aluminum rims
- Operator, 75 kg (165 lb)

Allow 3% variation in weight due to manufacturing tolerances

Travel proposals

Boom over front

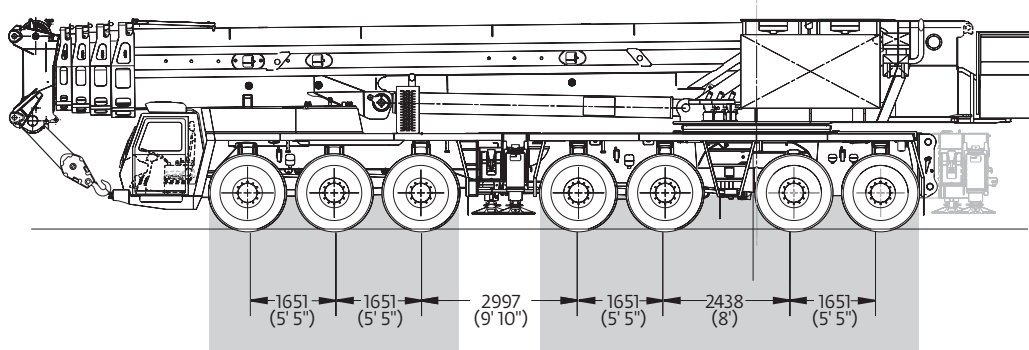

	Axles 1 - 3	Axles 4 - 7/8	Total GVW
Boom over front, rear outrigger box removed	37 724 kg (83,167 lb)	47 502 kg (104,722 lb)	85 226 kg (187,889 lb)
Boom over front, rear outrigger box installed	33 762 kg (74,431 lb)	58 193 kg (128,292 lb)	91 955 kg (202,723 lb)
Boom over front, 8th axle installed	43 562 kg (96,038 lb)	44 000 kg (97,003 lb)	87 563 kg (193,041 lb)

Unit equipped with:

- 20.5 tires on aluminum rims
- Operator, 75 kg (165 lb)
- Welded on MEGAWINGLIFT hardware

Allow 3% variation in weight due to manufacturing tolerances

Trailing boom (spread dolly) with axles 3 and 6 raised

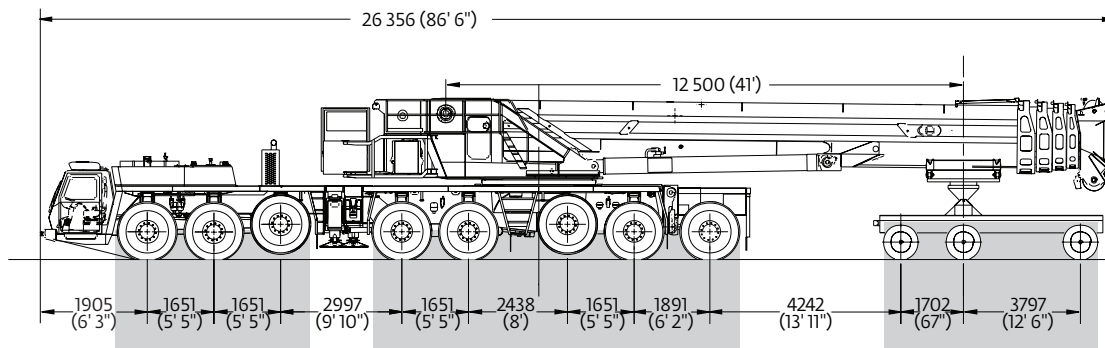

	Axles 1 - 2	Axles 4, 5, 7, 8	Dolly	Total GVW
Boom in dolly over rear, rear outrigger box removed, 8th axle installed, axles 3 and 6 raised	23 899 kg (52,689 lb)	40 743 kg (89,821 lb)	27 485 kg (60,594 lb)	92 127 kg (203,104 lb)

Unit equipped with:

- 20.5 tires on aluminum rims - axles 1 through 8
- Operator, 75 kg (165 lb)
- Welded on MEGAWINGLIFT hardware
- 3 axle dolly (4563 kg (10,000 lb))

Allow 3% variation in weight due to manufacturing tolerances

Working range

Main boom

197 ft main boom

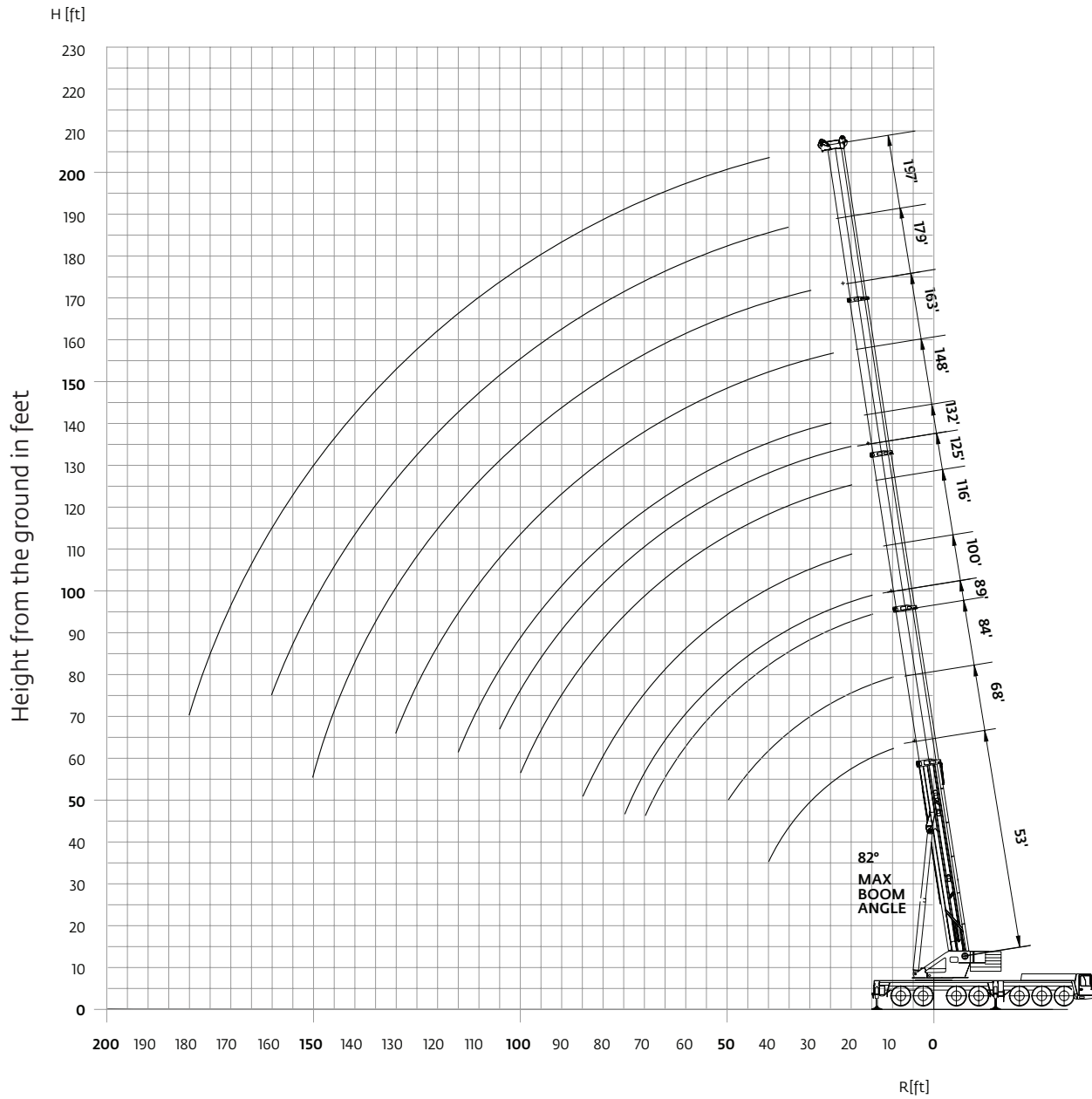





Operating radius in feet from axis of rotation

Hook heights shown in the working diagram do not consider loaded boom deflection.

Load charts

Main boom

16,0 m - 60 m
(53 ft - 197 ft)

120 000 kg
(264,500 lb)

29 ft 2 in spread
(100%)

360°

		Pounds (thousands)										
Feet	52.6	68.4	84.3	88.9	100.1	115.9	125.1	131.7	147.6	163.4	179.2	196.9
8	*1100.0											
10	678.0	624.0										
15	538.0	536.0	496.0	300.0								
20	438.0	442.0	438.0	300.0	410.0	372.0	284.0					
25	370.0	374.0	374.0	300.0	368.0	346.0	256.0	254.0				
30	318.0	320.0	320.0	298.0	318.0	316.0	232.0	228.0				
35	276.0	280.0	280.0	270.0	278.0	282.0	206.0	207.0	204.0	181.0		
40	242.0	244.0	246.0	238.0	244.0	246.0	187.0	186.0	186.0	168.0	155.0	123.0
45		215.0	216.0	209.0	219.0	217.0	170.0	170.0	154.0	142.0	131.0	119.0
50		194.0	196.0	185.0	195.0	193.0	154.0	155.0	141.0	131.0	122.0	112.0
55			176.0	165.0	175.0	174.0	143.0	145.0	129.0	121.0	114.0	105.0
60			159.0	147.0	159.0	157.0	132.0	136.0	120.0	111.0	106.0	98.0
65			144.0	136.0	144.0	142.0	121.0	128.0	111.0	104.0	98.0	92.0
70			131.0	122.0	130.0	127.0	111.0	119.0	102.0	97.0	92.0	86.0
75				109.0	117.0	114.0	104.0	113.0	96.0	90.0	87.0	80.0
80					106.0	104.0	95.0	107.0	90.0	83.0	81.0	76.0
85					97.0	94.0	86.0	98.0	84.0	79.0	75.0	72.0
90						87.0	78.0	90.0	79.0	75.0	71.0	67.0
95						84.0	70.0	82.0	75.0	70.0	68.0	63.0
100						79.0	64.0	76.0	72.0	66.0	64.0	60.0
105							59.0	70.0	69.0	62.0	60.0	57.0
110							56.0	65.0	66.0	59.0	56.0	54.0
115								61.0	62.0	56.0	53.0	51.0
120									57.0	52.0	51.0	47.0
125									54.0	49.0	49.0	45.0
130									50.0	47.0	46.0	43.4
135										46.0	44.0	41.4
140										43.4	41.2	39.6
145										40.6	38.6	37.6
150										38.2	36.0	35.8
155											33.6	33.8
160											31.4	31.6
165												29.4
170												27.6
175												25.8
180												24.2

Loads > 420,000 lb can only be lifted with additional equipment
 * Over rear, 20 ft outrigger span, with special equipment





16,0 m - 60 m
(53 ft - 197 ft)

100 000 kg
(220,400 lb)

29 ft 2 in spread
(100%)

360°

		Pounds (thousands)										
Feet	52.6	68.4	84.3	88.9	100.1	115.9	125.1	131.7	147.6	163.4	179.2	196.9
8	*788.0											
10	664.0	624.0										
15	526.0	524.0	496.0	300.0								
20	428.0	432.0	432.0	300.0	410.0	372.0	284.0					
25	360.0	364.0	364.0	300.0	362.0	346.0	256.0	254.0				
30	308.0	312.0	312.0	298.0	310.0	314.0	232.0	228.0	204.0	181.0		
35	264.0	268.0	268.0	262.0	272.0	270.0	206.0	207.0	186.0	168.0	155.0	119.0
40	228.0	232.0	236.0	226.0	236.0	234.0	187.0	186.0	168.0	155.0	141.0	123.0
45		206.0	208.0	196.0	207.0	205.0	170.0	170.0	154.0	142.0	131.0	119.0
50		180.0	183.0	172.0	183.0	180.0	154.0	155.0	141.0	131.0	122.0	112.0
55			159.0	150.0	158.0	155.0	143.0	145.0	129.0	121.0	114.0	105.0
60			139.0	130.0	139.0	136.0	127.0	136.0	120.0	111.0	106.0	98.0
65			123.0	115.0	123.0	120.0	111.0	124.0	111.0	104.0	98.0	92.0
70			110.0	108.0	109.0	109.0	98.0	111.0	102.0	97.0	92.0	86.0
75				96.0	98.0	102.0	87.0	99.0	94.0	90.0	87.0	80.0
80					89.0	93.0	80.0	90.0	88.0	83.0	81.0	76.0
85					81.0	84.0	75.0	82.0	83.0	78.0	75.0	72.0
90						77.0	70.0	74.0	76.0	71.0	71.0	67.0
95						71.0	65.0	68.0	69.0	67.0	67.0	63.0
100						65.0	60.0	64.0	64.0	63.0	61.0	60.0
105							55.0	61.0	59.0	58.0	56.0	56.0
110							50.0	57.0	54.0	54.0	52.0	52.0
115								53.0	50.0	49.0	48.0	48.0
120									46.0	46.0	43.8	44.0
125									44.0	42.4	40.4	40.6
130									41.2	39.4	37.4	37.6
135										36.4	34.6	34.6
140										34.0	32.0	32.0
145										31.6	29.6	29.6
150										29.4	27.2	27.4
155											25.2	25.4
160											23.4	23.4
165												21.6
170												20.0
175												18.4
180												17.0

Loads > 420,000 lb can only be lifted with additional equipment
 * Over rear, 20 ft outrigger span, with special equipment

Load charts

Main boom

 16.0 m - 60 m
 (53 ft - 197 ft)

 80 000 kg
 (176,300 lb)

 29 ft 2 in spread
 (100%)

 360°

		Pounds (thousands)										
Feet	52.6	68.4	84.3	88.9	100.1	115.9	125.1	131.7	147.6	163.4	179.2	196.9
8												
10	650.0	624.0										
15	512.0	514.0	496.0	300.0								
20	418.0	420.0	420.0	300.0	410.0	372.0	284.0					
25	352.0	354.0	354.0	300.0	352.0	346.0	256.0	254.0				
30	294.0	298.0	298.0	290.0	300.0	296.0	232.0	228.0	204.0	181.0		
35	250.0	252.0	258.0	246.0	256.0	242.0	206.0	207.0	186.0	168.0	146.0	
40	203.0	213.0	216.0	206.0	215.0	203.0	187.0	186.0	168.0	155.0	141.0	123.0
45		176.0	180.0	170.0	174.0	174.0	160.0	168.0	154.0	142.0	131.0	119.0
50		149.0	153.0	143.0	152.0	149.0	138.0	150.0	139.0	131.0	122.0	112.0
55			131.0	129.0	131.0	133.0	119.0	131.0	121.0	119.0	114.0	105.0
60			115.0	112.0	114.0	118.0	107.0	115.0	112.0	105.0	105.0	98.0
65			103.0	98.0	100.0	105.0	98.0	102.0	102.0	96.0	94.0	92.0
70			91.0	94.0	94.0	93.0	87.0	90.0	92.0	89.0	85.0	83.0
75				83.0	85.0	84.0	78.0	84.0	82.0	81.0	77.0	75.0
80					76.0	75.0	70.0	77.0	74.0	73.0	70.0	68.0
85					69.0	68.0	62.0	69.0	68.0	66.0	63.0	62.0
90						63.0	58.0	63.0	62.0	60.0	58.0	56.0
95							58.0	55.0	58.0	54.0	53.0	52.0
100							53.0	53.0	53.0	50.0	48.0	47.0
105								49.0	48.0	47.0	45.0	43.6
110								46.0	45.0	43.2	41.4	39.6
115									41.0	39.6	37.8	36.2
120										36.4	34.6	33.0
125										33.6	31.8	30.0
130										31.0	29.2	27.4
135											26.8	25.0
140											24.6	22.6
145											22.6	20.6
150											20.8	18.6
155												16.8
160												15.2
165												13.8
170												12.4
175												11.0
180												9.8

Loads > 420,000 lb can only be lifted with additional equipment

 16.0 m - 60 m
 (53 ft - 197 ft)

 60 000 kg
 (132,200 lb)

 29 ft 2 in spread
 (100%)

 360°

		Pounds (thousands)										
Feet	52.6	68.4	84.3	88.9	100.1	115.9	125.1	131.7	147.6	163.4	179.2	196.9
10	634.0	624.0										
15	500.0	500.0	496.0	300.0								
20	406.0	410.0	410.0	300.0	408.0	372.0	284.0					
25	336.0	340.0	340.0	300.0	338.0	314.0	256.0	254.0				
30	268.0	276.0	278.0	254.0	262.0	244.0	226.0	228.0	204.0	181.0		
35	205.0	215.0	219.0	208.0	212.0	199.0	182.0	194.0	179.0	168.0	146.0	
40	162.0	171.0	175.0	172.0	174.0	170.0	151.0	161.0	150.0	143.0	141.0	123.0
45		141.0	145.0	142.0	144.0	145.0	135.0	136.0	133.0	127.0	121.0	116.0
50		118.0	124.0	119.0	126.0	125.0	115.0	119.0	114.0	110.0	104.0	101.0
55			106.0	107.0	109.0	108.0	100.0	106.0	101.0	96.0	91.0	88.0
60			92.0	93.0	95.0	94.0	88.0	94.0	89.0	85.0	80.0	78.0
65			81.0	82.0	83.0	84.0	81.0	83.0	79.0	75.0	71.0	69.0
70			71.0	72.0	74.0	74.0	75.0	74.0	71.0	67.0	63.0	61.0
75				64.0	66.0	66.0	67.0	66.0	64.0	60.0	56.0	55.0
80					59.0	59.0	60.0	59.0	58.0	54.0	51.0	49.0
85					53.0	53.0	54.0	53.0	52.0	49.0	46.0	44.0
90						48.0	48.0	48.0	46.0	44.0	41.0	40.0
95							43.6	44.0	43.2	41.8	40.0	37.0
100							39.6	40.2	39.2	37.8	36.0	33.4
105								36.6	35.6	34.2	32.4	30.2
110								33.2	32.2	30.8	29.0	27.2
115									29.2	27.8	26.0	24.0
120										25.2	23.4	21.6
125										22.8	21.0	19.2
130										20.6	18.8	17.0
135											16.8	15.0
140											15.0	13.2
145											13.4	11.4
150											11.8	9.8
155												8.2
160												7.0
165												5.8
170												4.6
175												3.6

Loads > 420,000 lb can only be lifted with additional equipment

 16.0 m - 45 m
 (53 ft - 148 ft)

 0 kg
 (0 lb)

 29 ft 2 in spread
 (100%)

 360°

		Pounds (thousands)										
Feet	52.6	68.4	84.3	88.9	100.1	115.9	125.1	131.7	147.6			
10	586.0	584.0										
15	440.0	366.0	302.0	278.0								
20	199.0	180.0	163.0	159.0	146.0	130.0	124.0					
25	114.0	111.0	106.0	104.0	99.0	90.0	87.0	81.0	53.0			
30	72.0	75.0	74.0	73.0	71.0	66.0	64.0	60.0	40.2			
35	49.0	53.0	54.0	54.0	53.0	50.0	49.0	45.0	30.6			
40	34.0	38.6	40.6	41.0	40.4	38.2	37.6	34.8	23.4			
45		28.2	30.8	31.4	31.4	29.8	29.4	27.0	17.6			
50		20.6	23.4	24.0	24.4	23.0	23.0	20.8	13.0			
55			17.6	18.2	18.8	17.8	17.8	16.0	9.2			
60			13.0	13.6	14.2	13.6	13.6	11.8	6.0			
65			9.2	9.8	10.6	10.0	10.2	8.4				
70			6.0	6.8	7.6	7.0	7.2	5.6				
75				4.0	5.0	4.4	4.8					

THIS CHART IS ONLY A GUIDE AND SHOULD NOT BE USED TO OPERATE THE CRANE.

Working range

Main boom and MegaWingLift™

197 ft main boom

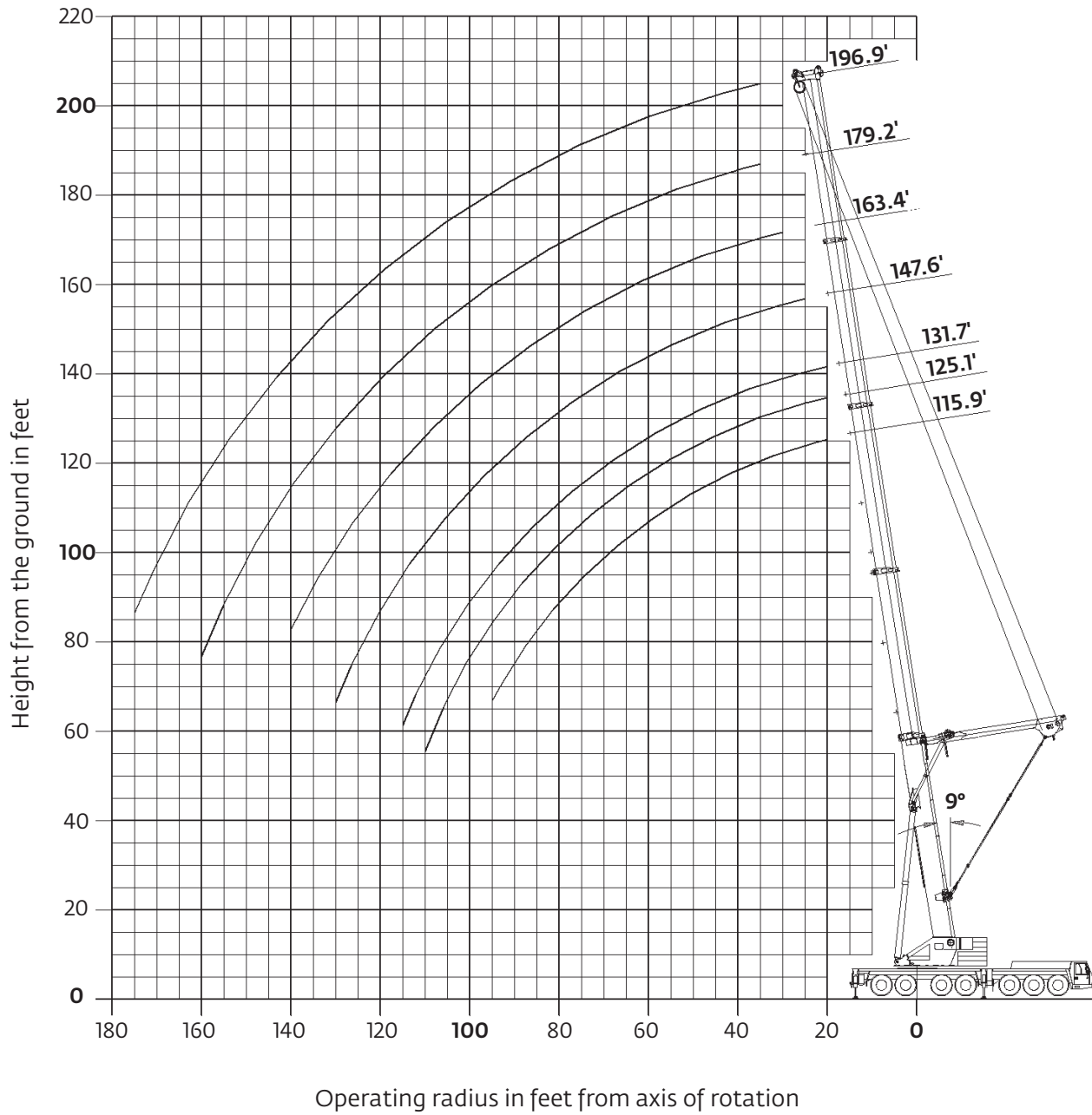

Hook heights shown in the working diagram do not consider loaded boom deflection.

Load charts

Main boom and MegaWingLift™

 35,3 m - 60 m
(116 ft - 197 ft)
  160 000 kg
(352,700 lb)
  29 ft 2 in spread
(100%)
  360°

Feet	115.9	125.1	131.7	147.6	163.4	179.2	196.9
20	352.0	270.0	330.0				
25	324.0	254.0	310.0	298.0			
30	298.0	242.0	280.0	268.0	222.0	213.0	
35	274.0	230.0	258.0	244.0	211.0	200.0	167.0
40	242.0	219.0	240.0	226.0	200.0	186.0	158.0
45	222.0	209.0	219.0	212.0	190.0	175.0	149.0
50	200.0	195.0	197.0	193.0	181.0	164.0	142.0
55	182.0	180.0	181.0	175.0	172.0	154.0	134.0
60	166.0	167.0	166.0	163.0	161.0	146.0	127.0
65	153.0	153.0	153.0	152.0	147.0	138.0	121.0
70	140.0	141.0	140.0	139.0	138.0	130.0	115.0
75	129.0	130.0	129.0	128.0	127.0	124.0	110.0
80	120.0	120.0	120.0	119.0	118.0	116.0	104.0
85	111.0	112.0	111.0	110.0	109.0	108.0	100.0
90	104.0	104.0	104.0	103.0	102.0	100.0	96.0
95	97.0	97.0	97.0	96.0	95.0	93.0	91.0
100		91.0	91.0	90.0	89.0	87.0	87.0
105		86.0	85.0	84.0	83.0	82.0	82.0
110		73.0	80.0	79.0	78.0	77.0	77.0
115			71.0	75.0	73.0	72.0	72.0
120				70.0	69.0	68.0	68.0
125				67.0	65.0	63.0	64.0
130				58.0	61.0	60.0	60.0
135					58.0	56.0	56.0
140					54.0	53.0	53.0
145						49.0	50.0
150						46.0	47.0
155						43.6	44.0
160						38.4	41.4
165							39.0
170							36.8
175							33.8

 35,3 m - 60 m
(116 ft - 197 ft)
  120 000 kg
(264,500 lb)
  29 ft 2 in spread
(100%)
  360°

Feet	115.9	125.1	131.7	147.6	163.4	179.2	196.9
20	352.0	270.0	330.0				
25	324.0	254.0	310.0	298.0			
30	298.0	242.0	280.0	268.0	222.0	213.0	
35	260.0	230.0	258.0	244.0	211.0	200.0	167.0
40	236.0	219.0	232.0	226.0	200.0	186.0	158.0
45	208.0	204.0	206.0	202.0	190.0	175.0	149.0
50	185.0	186.0	186.0	185.0	180.0	164.0	142.0
55	167.0	167.0	167.0	166.0	165.0	154.0	134.0
60	151.0	152.0	151.0	150.0	149.0	146.0	127.0
65	137.0	138.0	138.0	137.0	136.0	134.0	121.0
70	125.0	126.0	125.0	124.0	123.0	122.0	115.0
75	115.0	115.0	115.0	114.0	112.0	111.0	110.0
80	104.0	105.0	104.0	103.0	102.0	100.0	100.0
85	94.0	95.0	95.0	93.0	92.0	90.0	91.0
90	86.0	87.0	86.0	85.0	84.0	82.0	83.0
95	79.0	80.0	79.0	78.0	77.0	75.0	76.0
100		74.0	73.0	72.0	71.0	69.0	69.0
105		68.0	67.0	66.0	65.0	63.0	64.0
110		63.0	63.0	61.0	60.0	58.0	59.0
115			58.0	57.0	56.0	54.0	54.0
120				53.0	52.0	50.0	50.0
125				49.0	48.0	46.0	46.0
130				46.0	45.0	42.8	43.0
135					41.4	39.6	40.0
140					38.6	36.8	37.2
145						34.2	34.4
150						31.8	32.0
155						29.6	29.8
160						27.6	27.6
165							25.8
170							23.8
175							22.2

THIS CHART IS ONLY A GUIDE AND SHOULD NOT BE USED TO OPERATE THE CRANE.

The individual crane's load chart, operating instructions and other instructional plates must be read and understood prior to operating the crane.

Working range

Luffing jib

82 ft - 240 ft luffing jib - 81° main boom

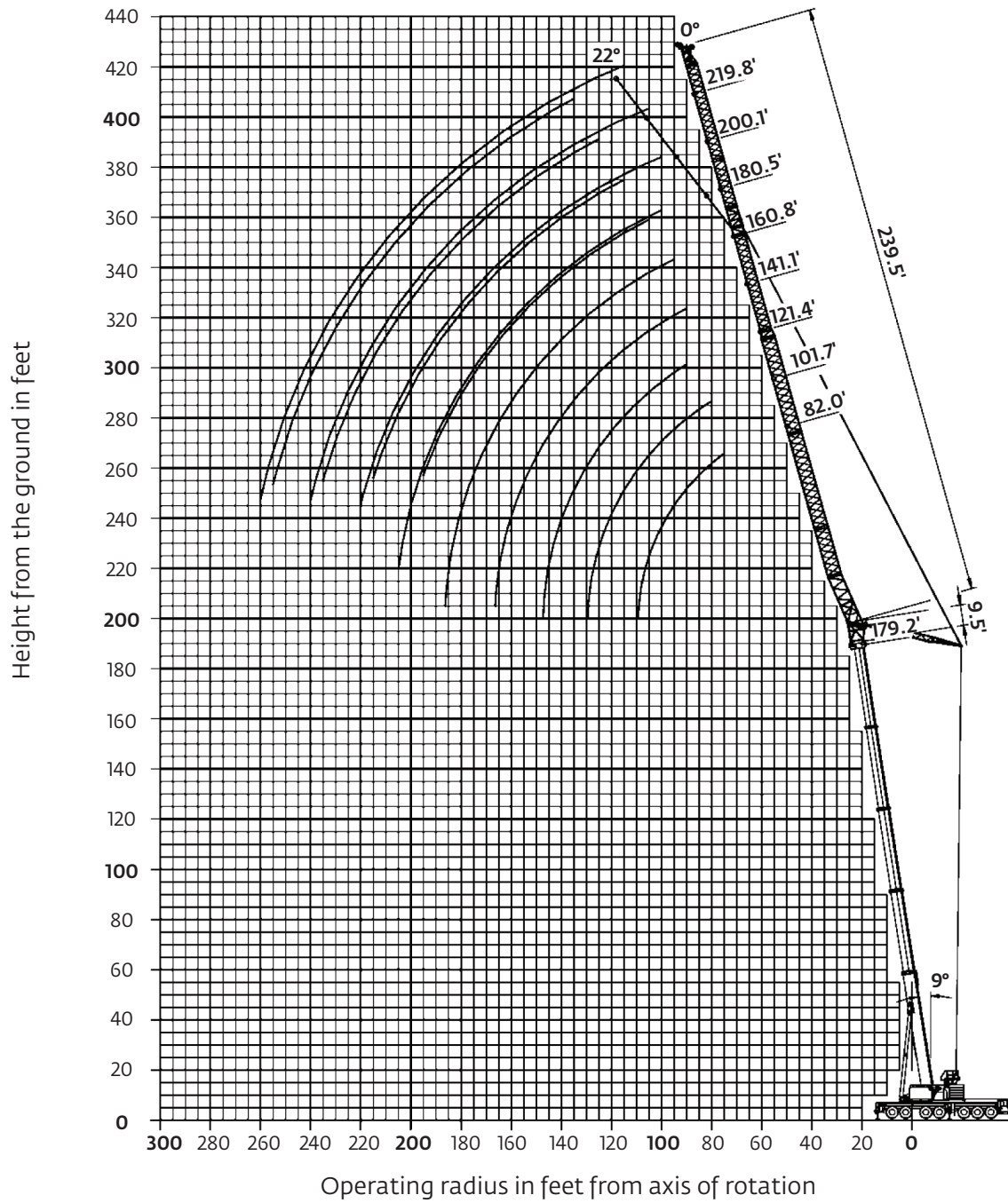



Hook heights shown in the working diagram do not consider loaded boom deflection.

Load charts

Luffing jib

 81°
 16,0 m + 2,9 m
 (52.6 ft + 9.5 ft)

 25 m - 73 m
 (82 ft - 240 ft)

 120 000 kg
 (264,500 lb)

 29 ft 2 in spread
 (100%)

 360°

		Pounds (thousands)									
Feet	82.0	101.7	121.4	141.1	160.8	180.5	200.1	219.8	239.5		
40	169.0	144.0									
45	160.0	140.0									
50	151.0	136.0									
55	142.0	132.0	114.0	92.0							
60	134.0	129.0	109.0	89.0	73.0						
65	128.0	125.0	106.0	88.0	72.0						
70	118.0	122.0	104.0	86.0	70.0	56.0	42.6				
75	102.0	118.0	102.0	84.0	69.0	54.0	41.4	32.6			
80	86.0	108.0	99.0	83.0	67.0	53.0	40.4	31.6	23.4		
85	70.0	96.0	96.0	81.0	65.0	52.0	39.2	30.8	22.8		
90		86.0	93.0	80.0	64.0	50.0	38.2	29.8	22.0		
95		75.0	88.0	78.0	62.0	49.0	37.2	29.0	21.4		
100		65.0	80.0	76.0	61.0	47.0	36.2	28.0	20.6		
105			73.0	74.0	59.0	46.0	35.2	27.0	20.0		
110			65.0	71.0	58.0	45.0	34.4	26.2	19.4		
115			58.0	68.0	57.0	43.6	33.4	25.2	18.8		
120			51.0	62.0	56.0	42.6	32.6	24.2	18.2		
125				57.0	54.0	41.6	31.8	23.2	17.6		
130				51.0	53.0	40.6	31.0	22.6	17.2		
135				46.0	50.0	39.6	30.2	22.0	16.6		
140					47.0	38.8	29.4	21.4	16.0		
145					43.2	38.0	28.4	20.8	15.4		
150					39.6	37.0	27.6	20.2	15.0		
155					36.2	36.2	26.6	19.6	14.6		
160						35.0	25.8	19.2	14.2		
165						33.4	24.8	18.6	13.6		
170						31.8	24.4	18.2	13.2		
175						29.6	23.8	17.8	12.8		
180							23.2	17.2	12.4		
185							22.8	16.8	12.0		
190							22.2	16.4	11.6		
195							21.6	15.8	11.2		
200								15.6	11.0		
205								15.2	10.6		
210								14.8	10.2		
215								14.4	9.8		
220									9.6		
225									9.2		
230									9.0		
235									8.6		

 81°
 25,7 m + 2,9 m
 (84.3 ft + 9.5 ft)

 25 m - 73 m
 (82 ft - 240 ft)

 120 000 kg
 (264,500 lb)

 29 ft 2 in spread
 (100%)

 360°

		Pounds (thousands)									
Feet	82.0	101.7	121.4	141.1	160.8	180.5	200.1	219.8	239.5		
40											
45	154.0										
50	145.0	125.0									
55	137.0	123.0	100.0								
60	129.0	120.0	99.0	79.0							
65	122.0	118.0	98.0	79.0							
70	117.0	116.0	97.0	79.0	63.0						
75	112.0	113.0	95.0	78.0	62.0	49.0	38.4				
80	107.0	111.0	93.0	77.0	61.0	48.0	37.6	29.6			
85	100.0	109.0	92.0	76.0	60.0	47.0	36.8	28.6			
90	81.0	105.0	90.0	75.0	59.0	46.0	36.0	27.8	21.0		
95		98.0	89.0	74.0	58.0	45.0	35.0	26.8	20.4		
100		87.0	88.0	73.0	57.0	44.0	34.2	26.0	20.0		
105		75.0	87.0	72.0	55.0	43.2	33.6	25.0	19.4		
110		62.0	81.0	71.0	54.0	42.2	32.8	24.4	18.8		
115			75.0	70.0	53.0	41.4	32.0	23.8	18.2		
120			67.0	69.0	52.0	40.6	31.2	23.2	17.6		
125				68.0	51.0	39.8	30.6	22.6	17.2		
130				64.0	50.0	39.0	29.8	22.0	16.6		
135				59.0	48.0	38.0	29.2	21.4	16.2		
140				53.0	47.0	37.4	28.6	21.0	15.8		
145					45.0	36.6	27.8	20.4	15.2		
150					43.6	35.8	27.2	20.0	14.8		
155					42.2	35.2	26.4	19.4	14.4		
160					40.6	34.4	25.8	18.8	14.0		
165						33.6	25.0	18.4	13.6		
170						33.0	24.2	18.0	13.2		
175						32.4	23.4	17.6	12.8		
180						31.8	22.8	17.0	12.4		
185							22.4	16.6	12.0		
190							22.0	16.2	11.6		
195							21.4	15.8	11.2		
200							21.0	15.4	10.8		
205								15.0	10.6		
210								14.6	10.2		
215								14.2	9.8		
220								13.8	9.6		
225									9.2		
230									9.0		
235									8.6		

THIS CHART IS ONLY A GUIDE AND SHOULD NOT BE USED TO OPERATE THE CRANE.

The individual crane's load chart, operating instructions and other instructional plates must be read and understood prior to operating the crane.

Load charts

Luffing jib

 81°
 35,3 m + 2,9 m
 (115.9 ft + 9.5 ft)

 25 m - 73 m
 (82 ft - 240 ft)

 120 000 kg
 (264,500 lb)

 29 ft 2 in spread
 (100%)

 360°

Feet	82.0	101.7	121.4	141.1	160.8	180.5	200.1	219.8	239.5
45									
50	116.0								
55	113.0	99.0							
60	107.0	99.0	80.0						
65	102.0	95.0	80.0						
70	97.0	92.0	80.0	65.0					
75	93.0	88.0	79.0	65.0	51.0				
80	89.0	84.0	77.0	64.0	51.0	40.4	32.0		
85	85.0	80.0	75.0	64.0	50.0	39.8	31.6		
90	82.0	77.0	72.0	63.0	49.0	39.2	31.2	23.8	
95	79.0	74.0	70.0	62.0	49.0	38.8	30.6	23.4	18.4
100		72.0	67.0	61.0	48.0	38.2	30.2	23.0	18.0
105		69.0	65.0	60.0	47.0	37.6	29.6	22.6	17.4
110		67.0	62.0	58.0	47.0	37.2	29.2	22.2	17.0
115		64.0	60.0	56.0	46.0	36.6	28.6	21.6	16.6
120			58.0	55.0	45.0	36.0	28.2	21.2	16.2
125			57.0	53.0	45.0	35.6	27.6	20.8	15.8
130			55.0	52.0	44.0	35.0	27.2	20.4	15.4
135				50.0	43.6	34.4	26.6	20.0	15.0
140				49.0	43.0	33.8	26.0	19.4	14.6
145				48.0	42.4	33.4	25.2	19.0	14.2
150				47.0	41.8	32.8	24.6	18.6	14.0
155					41.2	32.4	24.0	18.2	13.6
160					40.6	31.8	23.6	17.8	13.2
165					40.2	31.2	23.0	17.4	12.8
170					39.6	30.8	22.6	17.0	12.4
175						30.2	22.2	16.6	12.2
180						29.8	21.8	16.4	11.8
185						29.2	21.4	16.0	11.4
190						28.8	21.0	15.6	11.2
195							20.6	15.2	10.8
200							20.2	14.8	10.6
205							19.8	14.4	10.2
210								14.2	9.8
215								13.8	9.6
220								13.6	9.2
225								13.2	9.0
230									8.8
235									8.4
240									8.2

 81°
 45,0 m + 2,9 m
 (147.6 ft + 9.5 ft)

 25 m - 73 m
 (82 ft - 240 ft)

 120 000 kg
 (264,500 lb)

 29 ft 2 in spread
 (100%)

 360°

Feet	82.0	101.7	121.4	141.1	160.8	180.5	200.1	219.8	239.5
55									
60	86.0								
65	83.0								
70	79.0	70.0							
75	75.0	67.0	57.0	45.0					
80	71.0	65.0	57.0	45.0	37.2				
85	68.0	62.0	57.0	45.0	37.2				
90	65.0	60.0	55.0	45.0	37.2	29.8	23.2		
95	62.0	58.0	54.0	45.0	37.0	29.8	23.2	18.0	
100	59.0	56.0	52.0	45.0	36.8	29.4	23.2	18.0	13.6
105		53.0	50.0	45.0	36.4	29.2	22.8	18.0	13.6
110		52.0	49.0	45.0	36.2	29.0	22.6	17.8	13.6
115		50.0	47.0	44.0	36.0	28.8	22.4	17.6	13.4
120		49.0	46.0	42.6	35.8	28.6	22.2	17.4	13.2
125			44.0	41.2	35.4	28.2	22.0	17.2	13.0
130			43.0	40.0	35.2	28.0	21.6	16.8	12.8
135			41.8	38.8	35.0	27.8	21.4	16.6	12.6
140			40.4	37.6	34.6	27.6	21.2	16.4	12.2
145				36.4	33.8	27.2	20.8	16.2	12.0
150				35.4	33.2	27.0	20.6	15.8	11.8
155				34.4	32.4	26.8	20.4	15.6	11.6
160					31.8	26.4	20.0	15.4	11.4
165					31.0	26.0	19.8	15.0	11.0
170					30.2	25.6	19.6	14.8	10.8
175					29.2	25.4	19.2	14.6	10.6
180						25.0	19.0	14.4	10.4
185						24.6	18.8	14.0	10.0
190						24.4	18.4	13.8	9.8
195						24.0	18.2	13.6	9.6
200							18.0	13.2	9.4
205							17.6	13.0	9.2
210							17.4	12.8	9.0
215							17.2	12.6	8.6
220								12.2	8.4
225								12.0	8.2
230								11.8	8.0
235								11.6	7.8
240									7.6
245									7.4

THIS CHART IS ONLY A GUIDE AND SHOULD NOT BE USED TO OPERATE THE CRANE.

The individual crane's load chart, operating instructions and other instructional plates must be read and understood prior to operating the crane.

Load charts

Luffing jib

 81°
 49,8 m + 2,9 m
 (163.4 ft + 9.5 ft)

 25 m - 73 m
 (82 ft - 240 ft)

 120 000 kg
 (264,500 lb)

 29 ft 2 in spread
 (100%)

 360°

Feet	82.0	101.7	121.4	141.1	160.8	180.5	200.1	219.8	239.5
65									
70	67.0								
75	64.0	57.0							
80	62.0	57.0	45.0	37.0					
85	59.0	55.0	45.0	37.0					
90	57.0	53.0	45.0	37.0	29.2				
95	55.0	51.0	45.0	37.0	29.2	23.8	19.2		
100	53.0	50.0	45.0	37.0	29.2	23.8	19.2	14.6	
105		48.0	44.0	37.0	29.2	23.6	19.0	14.6	10.8
110		46.0	43.2	37.0	29.2	23.6	19.0	14.6	10.8
115		45.0	41.8	37.0	29.2	23.4	18.8	14.4	10.8
120		43.4	40.6	36.6	29.2	23.2	18.6	14.4	10.8
125			39.2	35.8	29.2	23.2	18.6	14.2	10.6
130			38.0	34.8	29.2	23.0	18.4	14.0	10.4
135			36.8	34.0	29.2	22.8	18.2	13.8	10.2
140			35.8	33.0	28.8	22.6	18.0	13.6	10.2
145				32.0	28.6	22.6	17.8	13.6	10.0
150				31.0	28.2	22.4	17.6	13.4	9.8
155				30.0	27.8	22.2	17.6	13.2	9.6
160				29.2	27.4	22.0	17.4	13.0	9.4
165					27.0	21.8	17.2	12.8	9.4
170					26.2	21.8	17.0	12.6	9.2
175					25.4	21.6	16.8	12.6	9.0
180					24.8	21.4	16.6	12.4	8.8
185						21.2	16.4	12.2	8.6
190						21.0	16.2	12.0	8.4
195						20.6	16.0	11.8	8.4
200						20.4	16.0	11.6	8.2
205							15.8	11.4	8.0
210							15.6	11.4	7.8
215							15.4	11.2	7.6
220							15.2	11.0	7.4
225								10.8	7.2
230								10.6	7.0
235								10.4	7.0
240								10.2	6.8
245									6.6
250									6.4
255									6.2

 81°
 54,6 m + 2,9 m
 (179.2 ft + 9.5 ft)

 25 m - 73 m
 (82 ft - 240 ft)

 120 000 kg
 (264,500 lb)

 29 ft 2 in spread
 (100%)

 360°

Feet	82.0	101.7	121.4	141.1	160.8	180.5	200.1	219.8	239.5
70									
75	55.0								
80	55.0	45.0							
85	55.0	45.0							
90	53.0	45.0	36.6	29.8					
95	51.0	45.0	36.6	29.8	23.8				
100	49.0	45.0	36.6	29.8	23.8	19.6	15.2		
105	47.0	43.2	36.6	29.8	23.8	19.6	15.2	11.6	
110	45.0	41.8	36.6	29.8	23.8	19.4	15.2	11.6	
115		40.4	36.6	29.8	23.8	19.4	15.2	11.6	8.4
120		39.0	36.2	29.8	23.8	19.4	15.0	11.6	8.4
125		37.8	35.2	29.8	23.8	19.2	15.0	11.6	8.4
130		36.4	34.0	29.8	23.8	19.2	15.0	11.4	8.2
135			33.0	29.8	23.8	19.0	14.8	11.4	8.2
140			32.0	29.2	23.8	19.0	14.8	11.2	8.0
145			31.0	28.4	23.8	18.8	14.6	11.2	8.0
150			30.0	27.4	23.8	18.8	14.6	11.0	7.8
155				26.6	23.6	18.6	14.4	11.0	7.8
160				25.8	23.4	18.6	14.4	10.8	7.6
165				25.2	23.2	18.4	14.2	10.8	7.6
170				24.4	23.0	18.4	14.2	10.6	7.4
175					22.4	18.2	14.0	10.4	7.4
180					21.8	18.2	13.8	10.4	7.2
185					21.2	18.0	13.8	10.2	7.2
190					20.4	18.0	13.6	10.2	7.0
195						17.6	13.6	10.0	6.8
200						17.2	13.4	10.0	6.8
205						16.8	13.4	9.8	6.6
210							13.2	9.6	6.6
215							13.0	9.6	6.4
220							13.0	9.4	6.2
225								9.2	6.2
230								9.2	6.0
235								9.0	5.8
240								8.8	5.8
245									5.6
250									5.6
255									5.4
260									5.2

THIS CHART IS ONLY A GUIDE AND SHOULD NOT BE USED TO OPERATE THE CRANE.

Working range

Luffing jib

82 ft - 240 ft luffing jib - 70° main boom

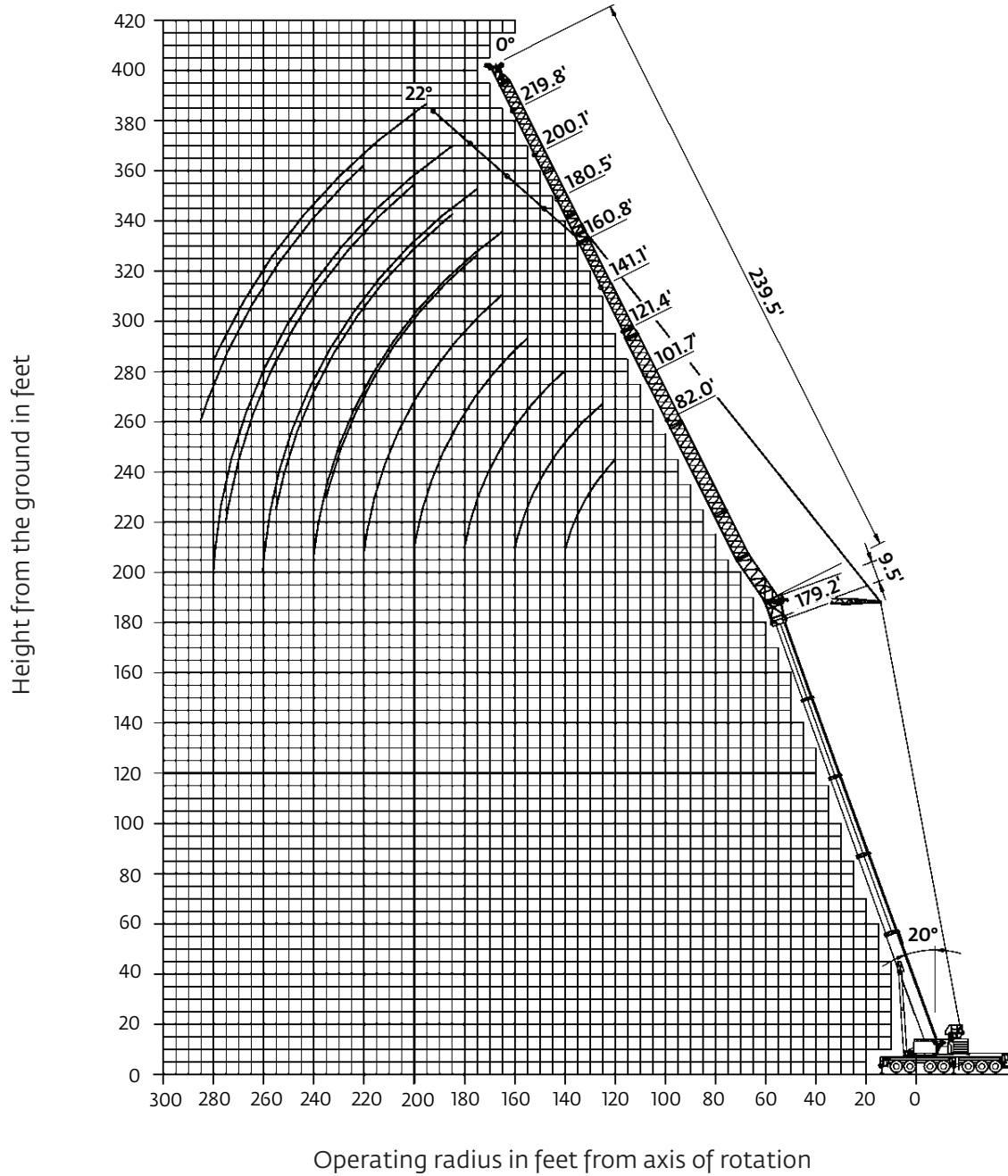

Hook heights shown in the working diagram do not consider loaded boom deflection.

Load charts

Luffing jib

70°
 16,0 m + 2,9 m
 (52,6 ft + 9,5 ft)

25 m - 73 m
 (82 ft - 240 ft)

120 000 kg
 (264,500 lb)

29 ft 2 in spread
 (100%)

360°

Pounds (thousands)

Feet	82.0	101.7	121.4	141.1	160.8	180.5	200.1	219.8	239.5
60	152.0								
65	142.0								
70	134.0								
75	128.0	125.0							
80	120.0	119.0							
85	112.0	112.0							
90	104.0	105.0	100.0						
95	98.0	97.0		81.0					
100		92.0	91.0	80.0	64.0				
105		86.0	85.0	79.0	62.0				
110		78.0	80.0	77.0	61.0				
115			76.0	75.0	59.0	46.0			
120			72.0	71.0	58.0	45.0	34.4		
125			68.0	67.0	57.0	43.6	33.4	25.4	
130			61.0	64.0	56.0	42.6	32.6	24.4	
135				61.0	54.0	41.6	31.8	23.4	17.6
140				58.0	53.0	40.6	31.0	22.6	17.2
145				55.0	51.0	39.6	30.2	22.0	16.6
150				49.0	50.0	38.8	29.4	21.4	16.0
155					48.0	38.0	28.8	20.8	15.6
160					45.0	37.0	28.0	20.2	15.0
165					43.2	36.2	27.2	19.8	14.6
170					40.0	35.4	26.4	19.2	14.2
175						34.6	25.6	18.8	13.6
180						34.0	24.8	18.2	13.2
185						33.0	24.0	17.8	12.8
190						31.4	23.2	17.2	12.4
195							22.6	16.8	12.0
200							22.2	16.4	11.6
205							21.6	16.0	11.2
210								15.6	10.8
215								15.0	10.6
220								14.6	10.2
225								14.4	9.8
230									9.6
235									9.2
240									9.0
245									8.6

70°
 75,7 m + 2,9 m
 (84,3 ft + 9,5 ft)

25 m - 73 m
 (82 ft - 240 ft)

120 000 kg
 (264,500 lb)

29 ft 2 in spread
 (100%)

360°

Pounds (thousands)

Feet	82.0	101.7	121.4	141.1	160.8	180.5	200.1	219.8	239.5
70									
75	116.0								
80	110.0								
85	104.0								
90	97.0	96.0							
95	90.0	89.0	89.0						
100	85.0	84.0	83.0						
105		78.0	78.0	75.0					
110		74.0	73.0	72.0					
115		70.0	69.0	68.0	57.0				
120		66.0	65.0	64.0	56.0				
125			62.0	61.0	55.0	42.4			
130			59.0	58.0	54.0	41.6			
135			56.0	55.0	53.0	40.8	31.4		
140			53.0	52.0	52.0	39.8	30.8	22.8	
145				50.0	49.0	39.0	30.0	22.2	16.8
150				48.0	47.0	38.2	29.4	21.6	16.2
155				46.0	45.0	37.6	28.6	21.0	15.8
160				43.6	43.2	36.8	28.0	20.4	15.4
165					41.4	36.0	27.2	20.0	14.8
170					39.6	35.2	26.4	19.4	14.4
175					38.0	34.6	25.6	19.0	14.0
180					36.4	33.8	24.8	18.6	13.6
185						33.2	24.0	18.0	13.2
190						32.6	23.6	17.6	12.8
195						31.8	23.0	17.2	12.4
200						30.4	22.4	16.6	12.0
205							22.0	16.2	11.6
210							21.6	15.8	11.2
215							21.0	15.4	11.0
220							20.6	15.0	10.6
225								14.6	10.2
230								14.4	10.0
235								14.0	9.6
240									9.4
245									9.0
250									8.8
255									8.4

THIS CHART IS ONLY A GUIDE AND SHOULD NOT BE USED TO OPERATE THE CRANE.

The individual crane's load chart, operating instructions and other instructional plates must be read and understood prior to operating the crane.

Load charts

Luffing jib

 70°
 35,3 m + 2,9 m
 (115.9 ft + 9.5 ft)

 25 m - 73 m
 (82 ft - 240 ft)

 120 000 kg
 (264,500 lb)

 29 ft 2 in spread
 (100%)

 360°

		Pounds (thousands)							
Feet	82.0	101.7	121.4	141.1	160.8	180.5	200.1	219.8	239.5
85									
90	72.0								
95	69.0								
100	66.0	63.0							
105	64.0	61.0	58.0						
110	61.0	58.0	55.0						
115	59.0	56.0	53.0						
120		54.0	52.0	49.0					
125		52.0	50.0	48.0					
130		51.0	48.0	46.0					
135		50.0	47.0	44.0	43.0				
140			46.0	43.0	41.6	36.8			
145			44.0	41.6	40.4	36.8	27.8		
150			42.8	40.4	39.0	35.8	27.4		
155			41.6	39.2	37.8	34.8	26.8	20.2	
160				38.0	36.8	34.0	26.2	19.6	14.8
165				37.0	35.6	33.0	25.6	19.2	14.4
170				36.0	34.6	32.0	25.0	18.8	14.0
175				35.0	33.6	31.2	24.2	18.4	13.8
180					32.8	30.2	23.6	18.0	13.4
185					31.6	29.4	23.2	17.6	13.0
190					30.4	28.6	22.8	17.2	12.6
195					29.2	27.8	22.4	16.8	12.2
200						27.0	22.0	16.4	12.0
205						26.0	21.6	16.0	11.6
210						25.0	21.0	15.8	11.2
215						24.0	20.6	15.4	11.0
220							20.2	15.0	10.6
225							19.8	14.6	10.4
230							19.6	14.2	10.0
235							19.2	14.0	9.8
240								13.6	9.4
245								13.4	9.2
250									8.8
255									8.6
260									8.4
265									8.0

 70°
 45,0 m + 2,9 m
 (147.6 ft + 9.5 ft)

 25 m - 73 m
 (82 ft - 240 ft)

 120 000 kg
 (264,500 lb)

 29 ft 2 in spread
 (100%)

 360°

		Pounds (thousands)							
Feet	82.0	101.7	121.4	141.1	160.8	180.5	200.1	219.8	239.5
95									
100	51.0								
105	51.0								
110	49.0								
115	46.0	42.0							
120	44.0	40.4							
125	42.0	39.0	36.8						
130	40.2	37.6	35.6						
135		36.4	34.4	32.0					
140		35.2	33.2	30.8					
145		34.0	32.0	29.8	28.8				
150		33.0	31.0	28.8	27.8				
155			30.0	27.8	26.8	24.6			
160			29.0	27.0	25.8	24.2	21.4		
165			28.2	26.0	25.0	23.4	21.2	16.4	
170			27.4	25.4	24.4	22.6	20.8	16.2	
175				24.8	23.8	21.8	20.2	16.0	11.8
180				24.0	23.0	21.0	19.6	15.8	11.8
185				23.4	22.4	20.4	19.0	15.6	11.4
190				22.8	21.6	19.6	18.4	15.2	11.2
195					21.0	19.0	17.8	15.0	11.0
200					20.4	18.4	17.2	14.8	10.8
205					19.8	17.8	16.6	14.6	10.6
210						17.2	16.0	14.2	10.2
215						16.8	15.6	14.0	10.0
220						16.2	15.0	13.6	9.8
225						15.8	14.6	13.4	9.6
230							14.0	13.0	9.4
235							13.6	12.6	9.0
240							13.2	12.2	8.8
245							12.8	11.8	8.6
250								11.4	8.4
255								11.2	8.2
260								10.8	8.0
265									7.8
270									7.6
275									7.2
280									7.0

THIS CHART IS ONLY A GUIDE AND SHOULD NOT BE USED TO OPERATE THE CRANE.

The individual crane's load chart, operating instructions and other instructional plates must be read and understood prior to operating the crane.

Load charts

Luffing jib

 70°
 49,8 m + 2,9 m
 (163.4 ft + 9.5 ft)

 25 m - 73 m
 (82 ft - 240 ft)

 120 000 kg
 (264,500 lb)

 29 ft 2 in spread
 (100%)

 360°

Feet	Pounds (thousands)								
	82.0	101.7	121.4	141.1	160.8	180.5	200.1	219.8	239.5
110									
115	39.0								
120	37.6	35.2							
125	36.2	33.8							
130	35.0	32.6							
135	33.8	31.6	29.6						
140		30.4	28.6						
145		29.4	27.6	25.4					
150		28.4	26.6	24.6					
155		27.6	25.8	24.0					
160			25.0	23.2	23.0	19.4			
165			24.4	22.4	22.2	19.4	17.2		
170			23.6	21.6	21.4	18.6	17.2		
175			23.0	21.0	20.6	18.0	16.8	13.6	
180				20.2	20.0	17.4	16.2	13.4	
185				19.6	19.2	16.6	15.6	13.2	9.6
190				19.0	18.6	16.0	15.0	13.2	9.6
195				18.4	18.0	15.6	14.6	12.8	9.4
200					17.4	15.0	14.0	12.4	9.2
205					16.8	14.4	13.4	12.0	9.0
210					16.2	14.0	13.0	11.6	9.0
215					15.8	13.4	12.6	11.2	8.8
220					15.2	13.0	12.2	10.8	8.6
225						12.6	11.6	10.4	8.4
230						12.0	11.2	10.0	8.2
235						11.6	10.8	9.6	8.0
240							10.4	9.4	7.8
245							10.0	9.0	7.6
250							9.8	8.6	7.2
255							9.4	8.2	7.0
260								8.0	6.8
265								7.6	6.6
270								7.4	6.2
275								7.0	6.0
280									5.8
285									5.4

 70°
 54,6 m + 2,9 m
 (179.2 ft + 9.5 ft)

 25 m - 73 m
 (82 ft - 240 ft)

 120 000 kg
 (264,500 lb)

 29 ft 2 in spread
 (100%)

 360°

Feet	Pounds (thousands)								
	82.0	101.7	121.4	141.1	160.8	180.5	200.1	219.8	239.5
115									
120	35.0								
125	33.6	29.8							
130	32.4	28.8							
135	31.2	27.6							
140	30.2	26.8	25.0						
145		25.8	24.4						
150		25.2	23.4						
155		24.4	22.6	20.6					
160		23.6	21.8	19.8					
165			21.2	19.2	18.2	15.4			
170			20.4	18.4	17.4	15.4			
175			19.8	17.8	16.8	14.8	12.8		
180			19.2	17.2	16.2	14.2	12.8		
185				16.6	15.6	13.8	12.4	10.6	
190				16.0	15.0	13.2	12.0	10.6	
195				15.6	14.6	12.6	11.4	10.2	7.6
200				15.0	14.0	12.2	11.0	9.8	7.6
205					13.6	11.6	10.6	9.4	7.4
210					13.0	11.2	10.0	9.0	7.4
215					12.6	10.8	9.6	8.6	7.2
220					12.2	10.4	9.2	8.4	7.0
225						10.0	9.0	8.0	6.6
230						9.6	8.6	7.6	6.4
235						9.2	8.2	7.2	6.0
240						8.8	7.8	7.0	5.8
245							7.4	6.6	5.4
250							7.2	6.2	5.2
255							6.8	6.0	4.8
260							6.6	5.6	4.6
265								5.4	4.4
270								5.2	4.0
275								4.8	3.8
280								4.6	3.6

THIS CHART IS ONLY A GUIDE AND SHOULD NOT BE USED TO OPERATE THE CRANE.

Working range

Luffing jib

82 ft - 240 ft luffing jib - 60° main boom

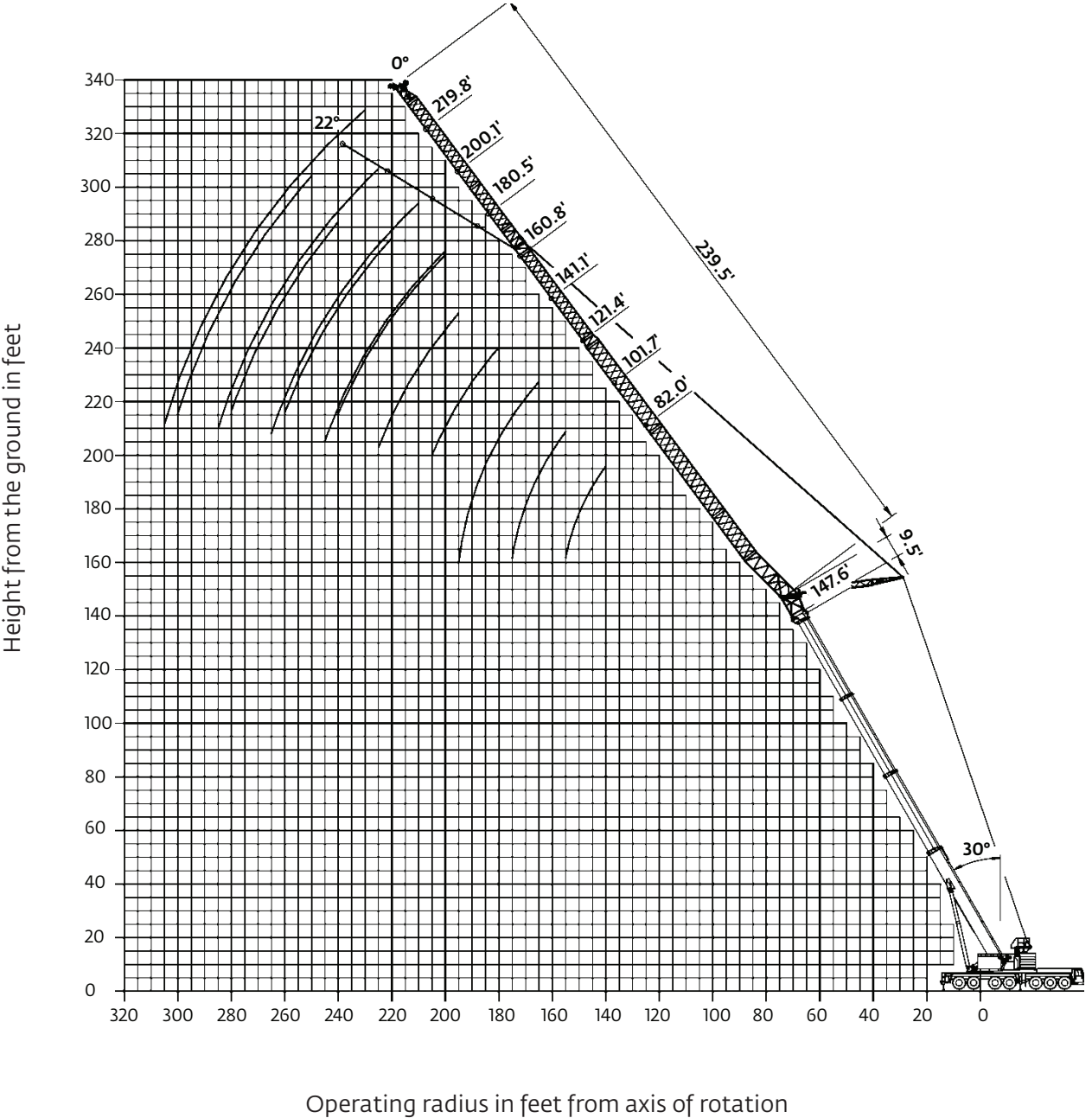



Hook heights shown in the working diagram do not consider loaded boom deflection.

Load charts

Luffing jib

 60°
 16,0 m + 2,9 m
 (52.6 ft + 9.5 ft)

 25 m - 73 m
 (82 ft - 240 ft)

 120 000 kg
 (264,500 lb)

 29 ft 2 in spread
 (100%)

 360°

Feet	Pounds (thousands)								
	82.0	101.7	121.4	141.1	160.8	180.5	200.1	219.8	239.5
90	100.0								
95	94.0	93.0							
100	88.0	87.0							
105		82.0	81.0						
110		77.0	76.0						
115		73.0	72.0						
120		69.0	68.0	67.0					
125			64.0	63.0					
130			61.0	60.0					
135			58.0	57.0	57.0				
140			56.0	55.0	54.0				
145				52.0	52.0	41.6			
150				50.0	49.0	40.6			
155				48.0	47.0	39.6	30.2		
160				46.0	45.0	38.8	29.4		
165					43.2	37.8	28.6	20.8	
170					41.4	37.0	28.0	20.2	
175					39.8	36.2	27.2	19.6	
180						35.4	26.4	19.2	14.0
185						34.6	25.4	18.6	13.6
190						33.8	24.4	18.2	13.2
195						33.2	23.8	17.6	12.8
200							23.2	17.2	12.4
205							22.6	16.8	12.0
210							22.0	16.4	11.6
215							21.6	15.8	11.2
220								15.4	10.8
225								15.0	10.6
230								14.8	10.2
235								14.4	9.8
240									9.6
245									9.2
250									9.0
255									8.6

 60°
 25,7 m + 2,9 m
 (84.3 ft + 9.5 ft)

 25 m - 73 m
 (82 ft - 240 ft)

 120 000 kg
 (264,500 lb)

 29 ft 2 in spread
 (100%)

 360°

Feet	Pounds (thousands)								
	82.0	101.7	121.4	141.1	160.8	180.5	200.1	219.8	239.5
95									
100	77.0								
105	72.0								
110	68.0								
115	64.0	63.0							
120		60.0							
125		57.0	56.0						
130		54.0	53.0						
135		51.0	50.0						
140			48.0	47.0					
145			46.0	44.0					
150			43.4	42.4					
155			41.6	40.4	39.6				
160				38.6	37.8	37.0			
165				37.0	36.2	35.4			
170				35.4	34.6	33.8			
175				34.0	33.2	32.4	28.0		
180					31.8	31.0	27.4		
185					30.6	29.8	26.8	19.4	
190					29.4	28.6	26.0	19.0	
195					28.2	27.4	25.4	18.4	
200						26.2	24.8	18.0	13.2
205						25.2	23.8	17.6	12.8
210						24.2	23.0	17.2	12.4
215						23.4	22.4	16.6	12.0
220							21.8	16.2	11.6
225							21.0	15.8	11.2
230							20.2	15.4	11.0
235							19.4	15.0	10.6
240								14.6	10.2
245								14.4	10.0
250								14.0	9.6
255								13.6	9.2
260									9.0
265									8.8
270									8.4
275									8.2

THIS CHART IS ONLY A GUIDE AND SHOULD NOT BE USED TO OPERATE THE CRANE.

Load charts

Luffing jib

 60°
 35,3 m + 2,9 m
 (115.9 ft + 9.5 ft)

 25 m - 73 m
 (82 ft - 240 ft)

 120 000 kg
 (264,500 lb)

 29 ft 2 in spread
 (100%)

 360°

Feet	82.0	101.7	121.4	141.1	160.8	180.5	200.1	219.8	239.5
115									
120	51.0								
125	49.0								
130	47.0								
135	46.0	43.6							
140		42.2							
145		40.6	38.6						
150		38.8	37.4						
155		36.8	36.2						
160			34.4	33.2					
165			33.0	31.8					
170			31.6	30.4					
175			30.2	29.0	28.2				
180				27.8	27.0				
185				26.6	25.8	25.0			
190				25.6	24.8	23.8			
195				24.4	23.8	22.8	22.0		
200					22.8	21.8	21.2		
205					21.8	21.0	20.2	17.6	
210					21.0	20.2	19.4	17.2	12.6
215					20.0	19.2	18.6	16.8	12.2
220						18.4	17.8	16.4	12.0
225						17.8	17.0	16.0	11.6
230						17.0	16.4	15.8	11.2
235						16.2	15.6	15.2	11.0
240							15.0	14.6	10.6
245							14.4	13.8	10.4
250								13.2	10.0
255								12.8	9.8
260								12.2	9.4
265								11.6	9.2
270									8.8
275									8.6
280									8.4
285									8.0

 60°
 45,0 m + 2,9 m
 (147.6 ft + 9.5 ft)

 25 m - 73 m
 (82 ft - 240 ft)

 120 000 kg
 (264,500 lb)

 29 ft 2 in spread
 (100%)

 360°

Feet	82.0	101.7	121.4	141.1	160.8	180.5	200.1	219.8	239.5
135									
140	33.4								
145	31.6								
150	30.0								
155	28.6	26.0							
160		25.2							
165		24.6	23.0						
170		23.8	22.2						
175		23.0	21.4						
180			20.8	18.8					
185			20.2	18.2					
190			19.6	17.6					
195			18.8	17.0	16.0				
200				16.4	15.4	13.6			
205				16.0	15.0	13.2			
210					14.4	12.6	15.2		
215					14.0	12.2	12.6		
220					13.4	11.6	10.6		
225					13.0	11.2	10.2	9.2	
230						10.8	9.8	8.8	8.4
235						10.4	9.4	8.4	8.4
240						10.0	9.0	8.2	8.2
245						9.6	8.6	7.8	7.8
250							8.2	7.4	7.6
255							7.8	7.0	7.2
260							7.6	6.8	7.0
265							7.2	6.4	6.6
270								6.2	6.4
275								5.8	6.0
280								5.6	5.6
285								5.4	5.2
290									4.8
295									4.4
300									4.0
305									3.6

Load charts

Luffing jib

 60°
 49,8 m + 2,9 m
 (163.4 ft + 9.5 ft)

 25 m - 61 m
 (82 ft - 200 ft)

 120 000 kg
 264,500 lb

 29 ft 2 in spread
 (100%)

 360°

Feet	82.0	101.7	121.4	141.1	160.8	180.5	200.1
140							
145	25.4						
150	24.8						
155	24.0						
160	23.2	21.2					
165		20.6					
170		19.8					
175		19.2	17.6				
180		18.6	17.0				
185			16.4	14.4			
190			15.8	14.0			
195			15.4	13.4			
200			14.8	13.0			
205				12.4	11.4		
210				12.0	11.0	9.2	
215				11.6	10.6	8.8	
220				11.2	10.2	8.4	7.6
225					9.8	8.0	7.2
230					9.4	7.6	6.8
235					9.0	7.2	6.4
240					8.6	6.8	6.0
245						6.6	5.8
250						6.2	5.4
255						6.0	5.2
260						5.6	4.8
265							4.6
270							4.2
275							4.0
280							3.8

 60°
 54,6 m + 2,9 m
 (179.2 ft + 9.5 ft)

 31 m - 49 m
 (102 ft - 161 ft)

 120 000 kg
 (264,500 lb)

 29 ft 2 in spread
 (100%)

 360°

Feet	101.7	121.4	141.1	160.8
170				
175	16.0			
180	15.4			
185	14.8	13.2		
190	14.4	12.8		
195	13.8	12.4		
200		11.8	10.0	
205		11.4	9.6	
210			9.2	
215			8.8	
220			8.4	7.4
225			8.0	7.0
230				6.6
235				6.4
240				6.0
245				5.8

THIS CHART IS ONLY A GUIDE AND SHOULD NOT BE USED TO OPERATE THE CRANE.

Working range

Luffing jib with MegaWingLift™

82 ft - 259 ft luffing jib - 81° main boom with MegaWingLift

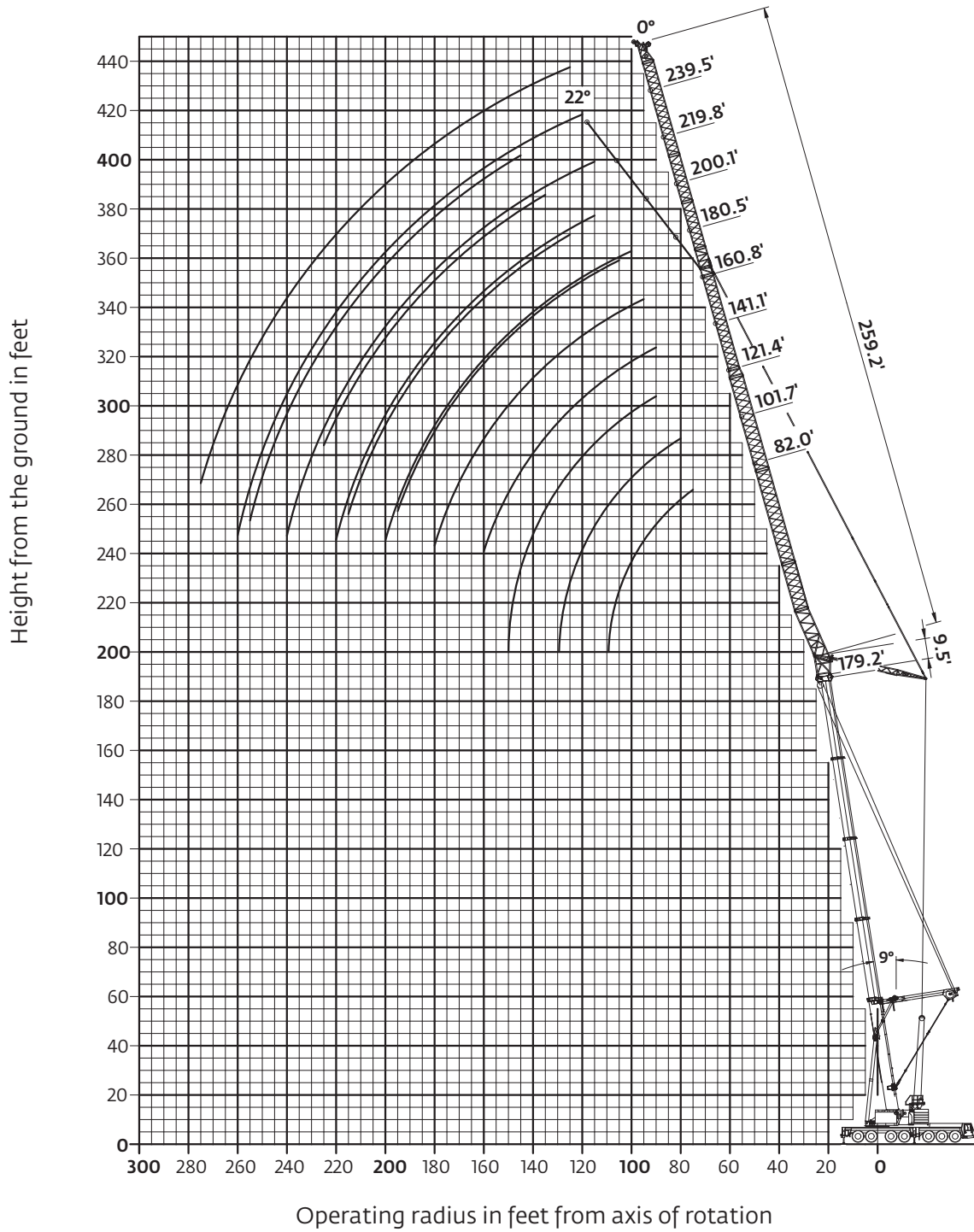



Hook heights shown in the working diagram do not consider loaded boom deflection.

Load charts

Luffing jib with MegaWingLift™

 81°
 35,3 m + 2,9 m
 (115,9 ft + 9,5 ft)

 25 m - 79 m
 (82 ft - 259 ft)

 160 000 kg
 (352,700 lb)

 29 ft 2 in spread
 (100%)

 360°

		Pounds (thousands)									
Feet	82.0	101.7	121.4	141.1	160.8	180.5	200.1	219.8	239.5	259.2	
50	141.0										
55	136.0	107.0									
60	129.0	107.0	85.0								
65	122.0	107.0	85.0								
70	115.0	107.0	85.0	69.0							
75	109.0	107.0	85.0	69.0	58.0						
80	105.0	107.0	85.0	69.0	58.0	48.0					
85	100.0	107.0	85.0	69.0	58.0	48.0					
90	97.0	105.0	85.0	69.0	58.0	48.0	39.6				
95		102.0	85.0	69.0	58.0	48.0	39.6	33.0			
100		98.0	85.0	69.0	58.0	48.0	39.6	33.0	26.2		
105		93.0	85.0	69.0	58.0	48.0	39.6	33.0	26.2	20.6	
110		81.0	85.0	69.0	58.0	48.0	39.6	33.0	26.2	20.6	
115			84.0	69.0	58.0	48.0	39.6	33.0	26.2	20.6	
120			80.0	69.0	58.0	48.0	39.6	33.0	26.2	20.6	
125			72.0	69.0	58.0	48.0	39.6	33.0	26.2	20.6	
130			63.0	69.0	58.0	48.0	39.6	33.0	26.2	20.6	
135				68.0	58.0	48.0	39.6	33.0	26.2	20.6	
140				63.0	58.0	47.0	39.6	33.0	25.8	20.6	
145				57.0	58.0	47.0	39.6	33.0	25.4	20.4	
150				50.0	57.0	46.0	39.6	33.0	24.8	20.0	
155					55.0	46.0	39.6	32.8	24.4	19.4	
160					51.0	46.0	39.6	32.2	23.8	19.0	
165					46.0	45.0	39.6	31.6	23.2	18.6	
170					40.8	45.0	39.6	30.6	22.8	18.2	
175						44.0	39.6	29.8	22.2	17.8	
180						41.4	39.6	29.0	21.8	17.2	
185						37.6	39.6	28.0	21.4	16.8	
190						33.2	39.6	27.2	20.8	16.4	
195							37.0	26.8	20.4	16.0	
200							34.0	26.2	19.8	15.6	
205							30.8	25.8	19.4	15.4	
210								25.4	19.0	15.0	
215								24.8	18.6	14.6	
220								24.6	18.4	14.2	
225									18.0	13.8	
230									17.6	13.6	
235									17.2	13.2	
240									17.0	13.0	
245										12.8	
250										12.4	
255										12.2	
260										12.0	

 81°
 45,0 m + 2,9 m
 (147,6 ft + 9,5 ft)

 25 m - 79 m
 (82 ft - 259 ft)

 160 000 kg
 (352,700 lb)

 29 ft 2 in spread
 (100%)

 360°

		Pounds (thousands)									
Feet	82.0	101.7	121.4	141.1	160.8	180.5	200.1	219.8	239.5	259.2	
60	119.0										
65	113.0										
70	109.0	101.0									
75	106.0	98.0	81.0								
80	103.0	94.0	81.0	63.0							
85	102.0	91.0	81.0	63.0							
90	100.0	89.0	81.0	63.0	54.0						
95	98.0	87.0	79.0	63.0	54.0	44.0					
100	93.0	85.0	78.0	63.0	54.0	44.0	36.6	30.6			
105		84.0	76.0	63.0	54.0	44.0	36.6	30.6	24.4		
110		82.0	74.0	63.0	54.0	44.0	36.6	30.6	24.4		
115		78.0	72.0	63.0	54.0	44.0	36.6	30.6	24.4	19.0	
120			71.0	63.0	54.0	44.0	36.6	30.6	24.4	19.0	
125			70.0	63.0	54.0	44.0	36.6	30.6	24.4	19.0	
130			68.0	62.0	54.0	44.0	36.6	30.6	24.4	19.0	
135			64.0	61.0	54.0	44.0	36.6	30.6	24.4	19.0	
140				60.0	54.0	44.0	36.6	30.6	24.4	19.0	
145				58.0	54.0	44.0	36.6	30.6	24.4	19.0	
150				55.0	54.0	44.0	36.6	30.6	24.4	19.0	
155				52.0	54.0	44.0	36.6	30.6	24.2	19.0	
160					50.0	43.8	36.6	30.6	23.8	19.0	
165					50.0	43.6	36.6	30.6	23.4	18.8	
170					48.0	43.2	36.6	30.6	23.0	18.4	
175						42.6	36.6	30.4	22.6	18.0	
180					45.0	42.2	36.6	29.6	22.0	17.6	
185						41.6	36.6	28.8	21.6	17.2	
190						41.0	36.6	28.0	21.2	16.8	
195						37.0	36.6	27.4	20.8	16.4	
200							36.6	26.6	20.4	16.0	
205							36.4	26.2	19.8	15.6	
210							33.6	25.8	19.4	15.4	
215							30.2	25.4	19.0	15.0	
220								25.0	18.6	14.6	
225								24.6	18.4	14.4	
230									18.0	14.0	
235									17.8	13.8	
240									17.4	13.4	
245									17.2	13.2	
250										12.8	
255										12.6	
260										12.4	
265										12.2	

THIS CHART IS ONLY A GUIDE AND SHOULD NOT BE USED TO OPERATE THE CRANE.

Load charts

Luffing jib with MegaWingLift™

 81°
 49,8 m + 2,9 m
 (163.4 ft + 9.5 ft)

 25 m - 79 m
 (82 ft - 259 ft)

 160 000 kg
 (352,700 lb)

 29 ft 2 in spread
 (100%)

 360°

		Pounds (thousands)									
Feet	82.0	101.7	121.4	141.1	160.8	180.5	200.1	219.8	239.5	259.2	
70	98.0										
75	95.0	85.0									
80	93.0	83.0	74.0								
85	91.0	81.0	73.0								
90	89.0	79.0	72.0	60.0							
95	86.0	78.0	70.0	60.0	50.0	41.2					
100	81.0	76.0	68.0	60.0	50.0	41.2					
105		74.0	67.0	60.0	50.0	41.2	34.2	28.6			
110		71.0	66.0	59.0	50.0	41.2	34.2	28.6			
115		68.0	64.0	58.0	50.0	41.2	34.2	28.6	22.6		
120		65.0	63.0	57.0	50.0	41.2	34.2	28.6	22.6	17.2	
125			60.0	55.0	50.0	41.2	34.2	28.6	22.6	17.2	
130			58.0	54.0	50.0	41.2	34.2	28.6	22.6	17.2	
135			55.0	52.0	50.0	41.2	34.2	28.6	22.6	17.2	
140			53.0	50.0	50.0	41.2	34.2	28.6	22.6	17.2	
145				48.0	48.0	41.2	34.2	28.6	22.6	17.2	
150				47.0	47.0	41.2	34.2	28.6	22.6	17.2	
155				45.0	46.0	41.2	34.2	28.6	22.6	17.2	
160				43.0	44.0	40.6	34.2	28.6	22.6	17.2	
165					43.0	39.8	34.2	28.6	22.6	17.2	
170					41.6	39.2	34.2	28.6	22.6	17.2	
175					40.2	38.4	34.2	28.6	22.4	17.2	
180					38.8	37.2	34.2	28.6	22.0	17.2	
185						36.2	34.2	28.4	21.6	17.2	
190						35.0	33.8	28.0	21.2	16.8	
195						34.0	32.8	27.4	20.8	16.4	
200							32.0	26.8	20.4	16.0	
205							31.0	26.2	20.0	15.8	
210							29.8	25.8	19.6	15.4	
215							28.4	25.4	19.2	15.0	
220							27.0	25.0	18.8	14.8	
225								24.6	18.4	14.4	
230								24.2	18.2	14.0	
235								23.6	17.8	13.8	
240									17.6	13.4	
245									17.2	13.2	
250									17.0	13.0	
255									16.8	12.6	
260										12.4	
265										12.2	

 81°
 54,6 m + 2,9 m
 (179.2 ft + 9.5 ft)

 25 m - 79 m
 (82 ft - 259 ft)

 160 000 kg
 (352,700 lb)

 29 ft 2 in spread
 (100%)

 360°

		Pounds (thousands)									
Feet	82.0	101.7	121.4	141.1	160.8	180.5	200.1	219.8	239.5	259.2	
75	85.0										
80	80.0	75.0									
85	76.0	71.0									
90	73.0	68.0	64.0	55.0							
95	69.0	65.0	61.0	54.0	47.0						
100	66.0	62.0	59.0	53.0	47.0	38.0					
105	63.0	60.0	56.0	51.0	47.0	38.0					
110	60.0	57.0	53.0	50.0	47.0	38.0					
115		54.0	51.0	48.0	46.0	38.0	31.6	25.2			
120		51.0	49.0	47.0	45.0	38.0	31.6	25.2	20.8		
125		49.0	47.0	45.0	45.0	38.0	31.6	25.2	20.8	15.8	
130		46.0	45.0	43.0	43.4	38.0	31.6	25.2	20.8	15.8	
135			43.2	41.4	42.0	38.0	31.6	25.2	20.8	15.8	
140			41.4	39.8	40.6	37.4	31.6	25.2	20.8	15.8	
145			39.6	38.2	39.2	36.4	31.6	25.2	20.8	15.8	
150			37.8	36.6	38.0	35.4	31.6	25.2	20.8	15.8	
155				35.2	36.8	34.6	31.6	25.2	20.8	15.8	
160				33.8	35.4	33.4	31.2	25.2	20.8	15.8	
165					34.2	31.8	30.6	25.2	20.8	15.8	
170					33.0	30.4	30.0	25.2	20.8	15.8	
175					31.8	29.0	28.8	25.2	20.8	15.8	
180					30.6	27.4	27.6	25.0	20.8	15.8	
185						26.6	26.4	24.4	20.8	15.8	
190						25.6	25.2	23.8	20.8	15.8	
195						24.6	24.0	23.0	20.6	15.8	
200						23.8	23.2	22.4	20.2	15.8	
205							22.4	21.8	19.8	15.8	
210							21.6	21.0	19.4	15.4	
215							20.8	20.4	19.0	15.2	
220							20.0	19.8	18.6	14.8	
225								19.0	18.2	14.6	
230								18.4	17.6	14.2	
235								17.8	17.0	14.0	
240								17.0	16.6	13.6	
245									16.0	13.4	
250									15.4	13.2	
255									14.8	12.8	
260									14.2	12.6	
265										12.4	
270										12.0	
275										11.8	

THIS CHART IS ONLY A GUIDE AND SHOULD NOT BE USED TO OPERATE THE CRANE.

The individual crane's load chart, operating instructions and other instructional plates must be read and understood prior to operating the crane.

Working range

Luffing jib with MegaWingLift™



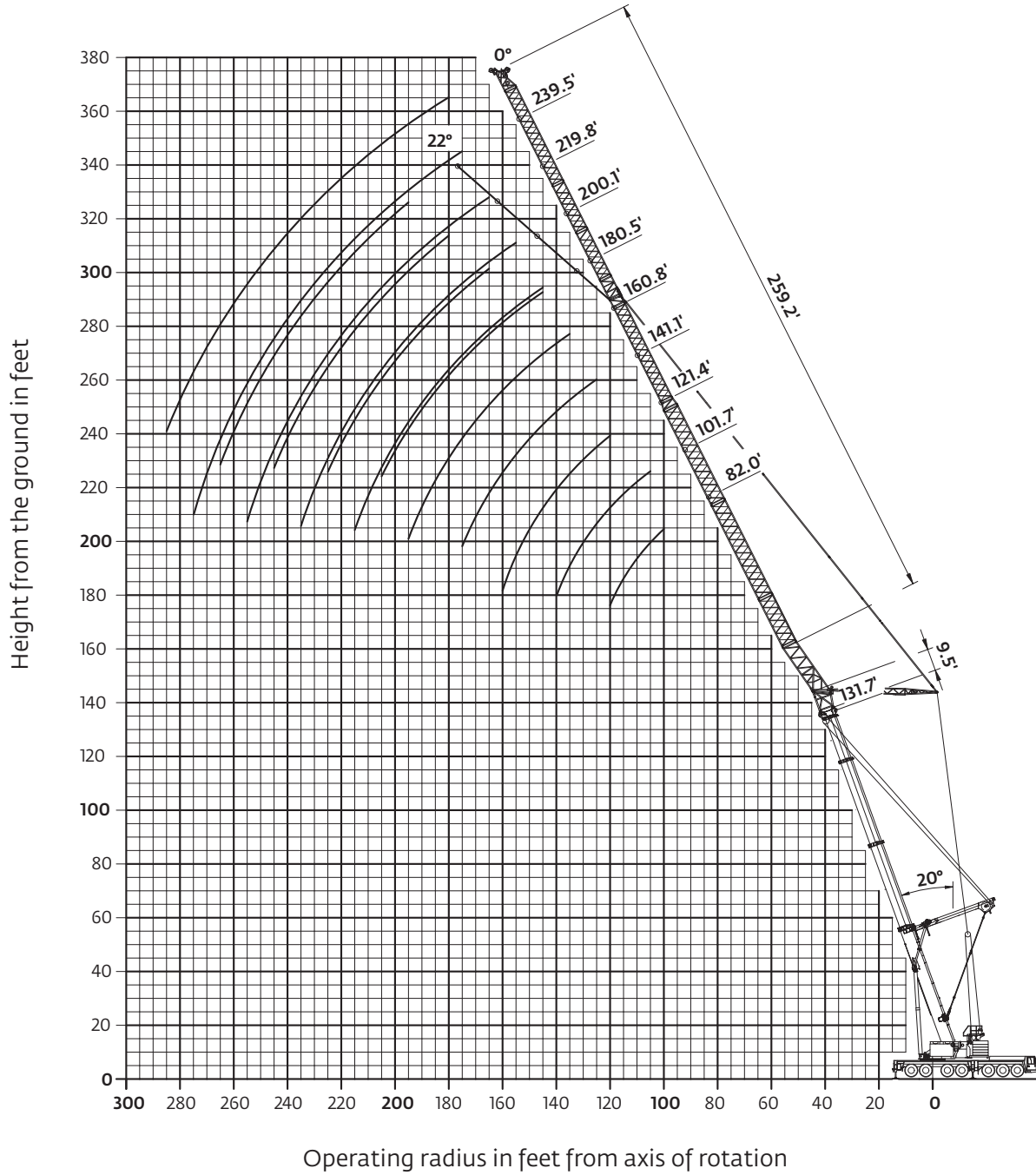

82 ft - 259 ft luffing jib - 70° main boom with MegaWingLift







Hook heights shown in the working diagram do not consider loaded boom deflection.

Load charts

Luffing jib with MegaWingLift™

 70° 34,3 m + 2,9 m (115.9 ft + 9.5 ft)
 25 m - 79 m (82 ft - 259 ft)
 160 000 kg (352,700 lb)
 29 ft 2 in spread (100%)
 360°

Feet	82.0	101.7	121.4	141.1	160.8	180.5	200.1	219.8	239.5	259.2
95	98.0									
100	93.0	91.0								
105	88.0	87.0								
110	84.0	83.0								
115	80.0	79.0	78.0							
120		75.0	74.0	71.0						
125		72.0	71.0	70.0	60.0					
130		68.0	68.0	67.0	60.0					
135		66.0	65.0	64.0	59.0					
140			62.0	61.0	59.0	48.0				
145			60.0	59.0	58.0	47.0	40.4			
150			58.0	57.0	56.0	47.0	40.4			
155			55.0	54.0	54.0	47.0	40.4			
160				52.0	52.0	47.0	40.4	33.4		
165				50.0	50.0	46.0	40.4	33.2	25.2	
170				49.0	48.0	46.0	40.4	32.8	24.8	
175					46.0	45.0	40.4	32.4	24.4	18.8
180					45.0	43.6	40.4	32.0	23.8	18.8
185					43.2	42.2	40.4	31.6	23.4	18.8
190					41.6	40.8	39.8	31.2	23.0	18.4
195						39.2	38.4	30.8	22.4	18.0
200						37.8	37.0	29.8	22.0	17.6
205						36.6	35.8	29.0	21.4	17.2
210							34.6	28.0	21.0	16.6
215							33.4	27.2	20.6	16.2
220							32.2	26.6	20.2	15.8
225							31.2	26.0	19.8	15.4
230								25.6	19.2	15.2
235								25.2	18.8	14.8
240								24.8	18.4	14.4
245								24.4	18.0	14.0
250									17.8	13.8
255									17.4	13.4
260									17.2	13.2
265									16.8	12.8
270										12.6
275										12.4
280										12.2

 70° 45,0 m + 2,9 m (147.6 ft + 9.5 ft)
 25 m - 79 m (82 ft - 259 ft)
 160 000 kg (352,700 lb)
 29 ft 2 in spread (100%)
 360°

Feet	82.0	101.7	121.4	141.1	160.8	180.5	200.1	219.8	239.5	259.2
105	83.0									
110	79.0									
115	75.0	71.0								
120	72.0	69.0								
125	68.0	68.0	62.0							
130	65.0	65.0	61.0							
135		62.0	59.0	54.0						
140		59.0	58.0	53.0	51.0					
145		57.0	56.0	53.0	50.0					
150		55.0	54.0	53.0	49.0					
155			52.0	51.0	48.0	39.6				
160			50.0	49.0	47.0	39.6	37.0			
165			48.0	47.0	46.0	39.6	37.0			
170			46.0	45.0	44.0	39.6	37.0			
175				43.8	42.8	39.6	37.0	31.2		
180				42.2	41.2	39.6	36.6	31.2	24.0	
185					39.8	38.4	36.2	31.0	23.6	
190					38.4	37.0	35.6	30.8	23.4	
195					37.0	35.6	34.8	30.6	23.0	17.4
200					35.6	34.4	33.4	30.4	22.6	17.4
205					34.4	33.0	32.2	30.0	22.2	17.4
210						32.0	31.2	29.8	21.8	17.4
215						30.8	30.0	29.0	21.4	17.0
220						29.8	29.0	28.2	21.0	16.6
225							28.0	27.4	20.6	16.2
230							27.0	26.4	20.2	15.8
235							26.0	25.4	19.8	15.4
240							25.2	24.6	19.4	15.2
245							24.2	23.8	19.0	14.8
250								23.0	18.6	14.6
255								22.2	18.2	14.2
260								21.4	18.0	14.0
265									17.6	13.6
270									17.4	13.4
275									17.0	13.2
280									16.8	12.8
285										12.6
290										12.4
295										12.0

THIS CHART IS ONLY A GUIDE AND SHOULD NOT BE USED TO OPERATE THE CRANE.

The individual crane's load chart, operating instructions and other instructional plates must be read and understood prior to operating the crane.

Load charts

Luffing jib with MegaWingLift™

 70°
 49,8 m + 2,9 m
 (163.4 ft + 9.5 ft)

 25 m - 79 m
 (82 ft - 259 ft)

 160 000 kg
 (352,700 lb)

 29 ft 2 in spread
 (100%)

 360°

Feet	Pounds (thousands)									
	82.0	101.7	121.4	141.1	160.8	180.5	200.1	219.8	239.5	259.2
115	72.0									
120	70.0	62.0								
125	67.0	60.0								
130	64.0	59.0								
135	61.0	58.0	52.0							
140		56.0	51.0	46.0						
145		55.0	50.0	46.0						
150		52.0	49.0	45.0						
155		50.0	48.0	44.0	42.2					
160			47.0	43.2	41.6	35.2				
165			45.0	42.2	40.8	35.2				
170			43.6	41.2	40.8	35.2				
175			42.0	39.8	39.6	35.2	32.0			
180				38.4	39.0	35.0	31.6	28.4		
185				37.2	38.0	34.6	31.2	28.2		
190				35.8	36.6	34.0	30.6	27.8		
195					35.4	33.6	30.4	27.4	22.4	
200					34.0	32.8	30.0	27.0	22.2	
205					32.8	31.6	29.6	26.6	22.0	16.8
210					31.6	30.4	29.2	26.4	21.6	16.8
215					30.6	29.4	28.4	26.0	21.4	16.8
220						28.4	27.4	25.6	21.0	16.8
225						27.4	26.4	25.0	20.8	16.4
230							25.4	24.4	20.4	16.0
235							24.6	23.8	20.0	15.8
240							23.8	23.2	19.6	15.4
245							22.8	22.4	19.2	15.0
250							22.0	21.6	19.0	14.8
255							21.2	20.8	18.6	14.4
260								20.0	18.2	14.2
265								19.4	18.0	13.8
270									17.6	13.6
275									17.4	13.4
280									17.0	13.0
285									16.4	12.8
290										12.6
295										12.2
300										12.0

 70°
 54,6 m + 2,9 m
 (179.2 ft + 9.5 ft)

 25 m - 79 m
 (82 ft - 259 ft)

 160 000 kg
 (352,700 lb)

 29 ft 2 in spread
 (100%)

 360°

Feet	Pounds (thousands)									
	82.0	101.7	121.4	141.1	160.8	180.5	200.1	219.8	239.5	259.2
120	57.0									
125	53.0	49.0								
130	51.0	47.0								
135	49.0	46.0								
140	47.0	43.8	41.4							
145		42.2	39.8	37.2						
150		40.6	38.4	36.0						
155		39.0	37.0	34.6						
160		37.4	35.6	33.4	34.6					
165			34.4	32.2	33.6					
170			33.0	31.0	32.6					
175			31.8	29.6	31.4	28.0				
180			30.6	28.0	29.6	26.6	25.2			
185				26.2	27.8	25.8	24.4	23.0		
190				25.0	26.6	25.0	23.8	22.4		
195				24.0	25.8	24.2	23.0	21.8		
200					25.0	23.4	22.4	21.2	19.6	
205					24.2	22.8	21.6	20.6	19.2	
210					23.4	22.0	21.0	20.0	18.6	15.2
215					22.6	21.4	20.4	19.4	18.2	15.2
220					21.8	20.6	19.8	18.8	17.6	15.2
225						20.0	19.2	18.2	17.2	15.2
230						19.2	18.6	17.6	16.6	15.0
235							18.6	17.2	16.2	14.6
240							17.4	16.6	15.6	14.2
245								16.2	15.2	13.6
250								16.2	14.6	13.2
255								15.6	14.2	12.8
260								15.0	14.6	12.4
265									14.2	12.0
270									13.6	11.6
275									13.2	11.2
280										10.8
285										10.6
290										10.2
295										9.8
300										9.4
305										9.0
310										8.6

THIS CHART IS ONLY A GUIDE AND SHOULD NOT BE USED TO OPERATE THE CRANE.

Working range

Luffing jib with MegaWingLift™

82 ft - 259 ft luffing jib - 60° main boom with MegaWingLift

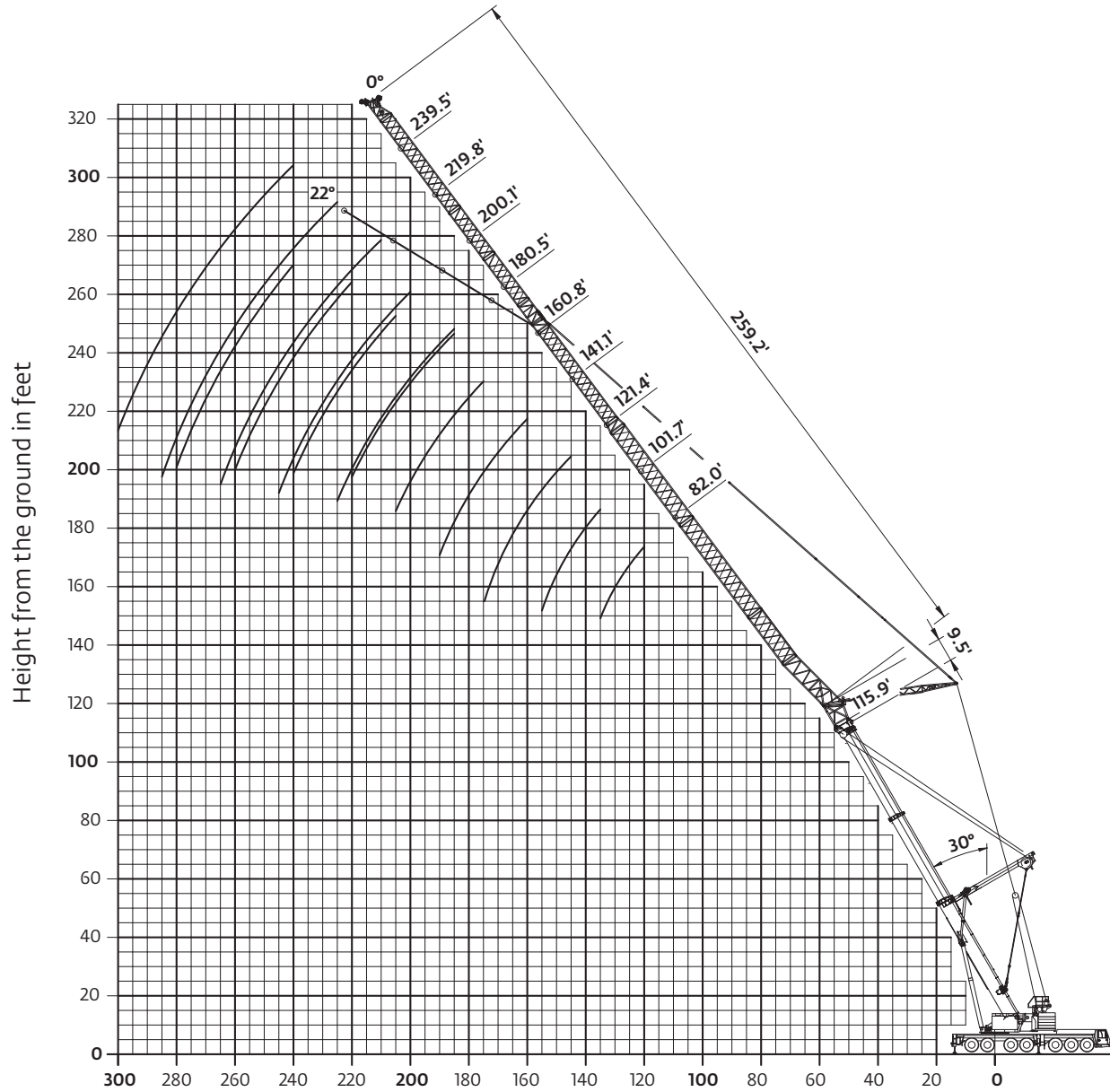



Operating radius in feet from axis of rotation

Hook heights shown in the working diagram do not consider loaded boom deflection.

Load charts

Luffing jib with MegaWingLift™

 60°
 35,3 m + 2,9 m
 (115.9 ft + 9.5 ft)

 25 m - 79 m
 (82 ft - 259 ft)

 160 000 kg
 (352,700 lb)

 29 ft 2 in spread
 (100%)

 360°

Feet	82.0	101.7	121.4	141.1	160.8	180.5	200.1	219.8	239.5	259.2
120	68.0									
125	65.0									
130	62.0									
135	60.0	58.0								
140		56.0								
145		54.0	53.0							
150		52.0	51.0							
155		50.0	49.0							
160			47.0	45.0						
165			45.0	43.6						
170			43.4	42.0						
175			41.6	40.4	39.4					
180				38.8	37.8					
185				37.4	36.4	35.0				
190				36.0	35.0	33.6				
195					33.8	32.4				
200					32.6	31.2	30.2			
205					31.4	30.0	29.0			
210						29.0	28.0	27.2		
215						27.8	27.0	26.2		
220						26.8	26.0	25.4		
225						26.0	25.0	24.4	21.4	
230							24.2	23.6	20.8	
235							23.4	22.6	20.4	
240							22.4	21.8	20.0	15.4
245							21.6	21.0	19.6	15.4
250								20.4	19.2	15.0
255								19.6	18.8	14.6
260								19.0	18.4	14.2
265								18.2	17.8	14.0
270									17.2	13.6
275									16.6	13.4
280									16.0	13.0
285									15.4	12.8
290										12.6
295										12.4
300										12.0

 60°
 45,0 m + 2,9 m
 (147.6 ft + 9.5 ft)

 25 m - 79 m
 (82 ft - 259 ft)

 160 000 kg
 (352,700 lb)

 29 ft 2 in spread
 (100%)

 360°

Feet	82.0	101.7	121.4	141.1	160.8	180.5	200.1	219.8	239.5	259.2
140	52.0									
145	50.0									
150	48.0									
155	46.0	44.0								
160		42.6								
165		40.8	39.6							
170		39.2	38.2							
175		37.6	36.6	35.0						
180			35.2	33.6						
185			34.0	32.4						
190			32.6	31.2						
195			31.4	30.0	29.0					
200				28.8	27.8					
205				27.8	26.8	25.6				
210					25.8	24.8				
215					24.8	23.8				
220					24.0	22.8	22.0			
225					23.0	22.0	21.0			
230						21.2	20.2	19.6		
235						20.4	19.6	18.8		
240						19.6	18.8	18.2	17.2	
245						18.8	18.0	17.4	16.6	
250							17.4	16.8	15.8	14.4
255							16.6	16.2	15.2	14.2
260							16.0	15.4	14.6	13.6
265							15.4	14.8	14.0	13.0
270								14.2	13.4	12.4
275								13.8	12.8	11.8
280								13.2	12.4	11.4
285								12.6	11.8	10.8
290									11.4	10.4
295									10.8	9.8
300									10.4	9.4
305										9.0
310										8.6
315										8.0
320										7.6

THIS CHART IS ONLY A GUIDE AND SHOULD NOT BE USED TO OPERATE THE CRANE.

Load charts

Luffing jib with MegaWingLift™

 60°
 49,8 m + 2,9 m (163.4 ft + 9.5 ft)

 25 m - 79 m
 (82 ft - 259 ft)

 160 000 kg
 (352,700 lb)

 29 ft 2 in spread
 (100%)

 360°

		Pounds (thousands)									
Feet	82.0	101.7	121.4	141.1	160.8	180.5	200.1	219.8	239.5	259.2	
145	47.0										
150	45.0										
155	43.6										
160	41.8	40.4									
165		38.8									
170		37.2									
175		35.6	34.6								
180		34.2	33.2								
185			32.0	30.2							
190			30.8	29.2							
195			29.6	28.0							
200			28.4	27.0	26.4						
205				26.0	25.4						
210				25.0	24.4	22.8					
215				24.0	23.6	22.0					
220				23.0	22.6	21.2					
225					21.8	20.2	19.2				
230					21.0	19.6	18.6				
235					20.2	18.8	17.8				
240					19.4	18.0	17.0	16.2			
245						17.4	16.4	15.6			
250						16.6	15.8	15.0	13.8		
255						16.0	15.2	14.4	13.2		
260							14.6	13.8	12.6		
265							14.0	13.2	12.2	10.6	
270							13.4	12.6	11.6	10.6	
275							12.8	12.2	11.0	10.0	
280							12.2	11.6	10.6	9.6	
285								11.0	10.2	9.0	
290								10.6	9.6	8.6	
295								10.2	9.2	8.2	
300									8.8	7.8	
305									8.2	7.2	
310									7.8	6.8	
315										6.4	
320										6.2	
325										5.8	
330										5.4	

 60°
 54,6 m + 2,9 m (179.2 ft + 9.5 ft)

 25 m - 79 m
 (82 ft - 259 ft)

 160 000 kg
 (352,700 lb)

 29 ft 2 in spread
 (100%)

 360°

		Pounds (thousands)									
Feet	82.0	101.7	121.4	141.1	160.8	180.5	200.1	219.8	239.5	259.2	
160	39.6										
165	38.0										
170	36.4										
175	34.8	33.4									
180		32.2									
185		31.0	29.0								
190		29.8	27.8								
195			25.8	23.2							
200			24.6	22.4							
205			23.6	21.6							
210				21.0	22.6						
215				20.2	21.8						
220				19.4	20.8						
225				18.8	20.0	18.6					
230					19.4	17.8					
235					18.6	17.0					
240					17.8	16.4	15.4				
245					17.2	15.8	14.6				
250						15.0	14.0	13.2			
255						14.4	13.4	12.6			
260						13.8	12.8	12.0	10.8		
265						13.2	12.4	11.6	10.2		
270							11.8	11.0	9.8	7.8	
275							11.2	10.6	9.2	7.8	
280							10.8	10.0	8.8	7.6	
285							10.2	9.6	8.4	7.2	
290								9.2	8.0	6.8	
295								8.6	7.6	6.4	
300								8.2	7.0	6.0	
305								7.8	6.6	5.6	
310									6.2	5.2	
315									6.0	4.8	
320									5.6	4.6	
325										4.2	
330										3.8	
335										3.6	
340										3.2	

THIS CHART IS ONLY A GUIDE AND SHOULD NOT BE USED TO OPERATE THE CRANE.

The individual crane's load chart, operating instructions and other instructional plates must be read and understood prior to operating the crane.

Working range

Lattice extension

39 ft - 230 ft boom extension

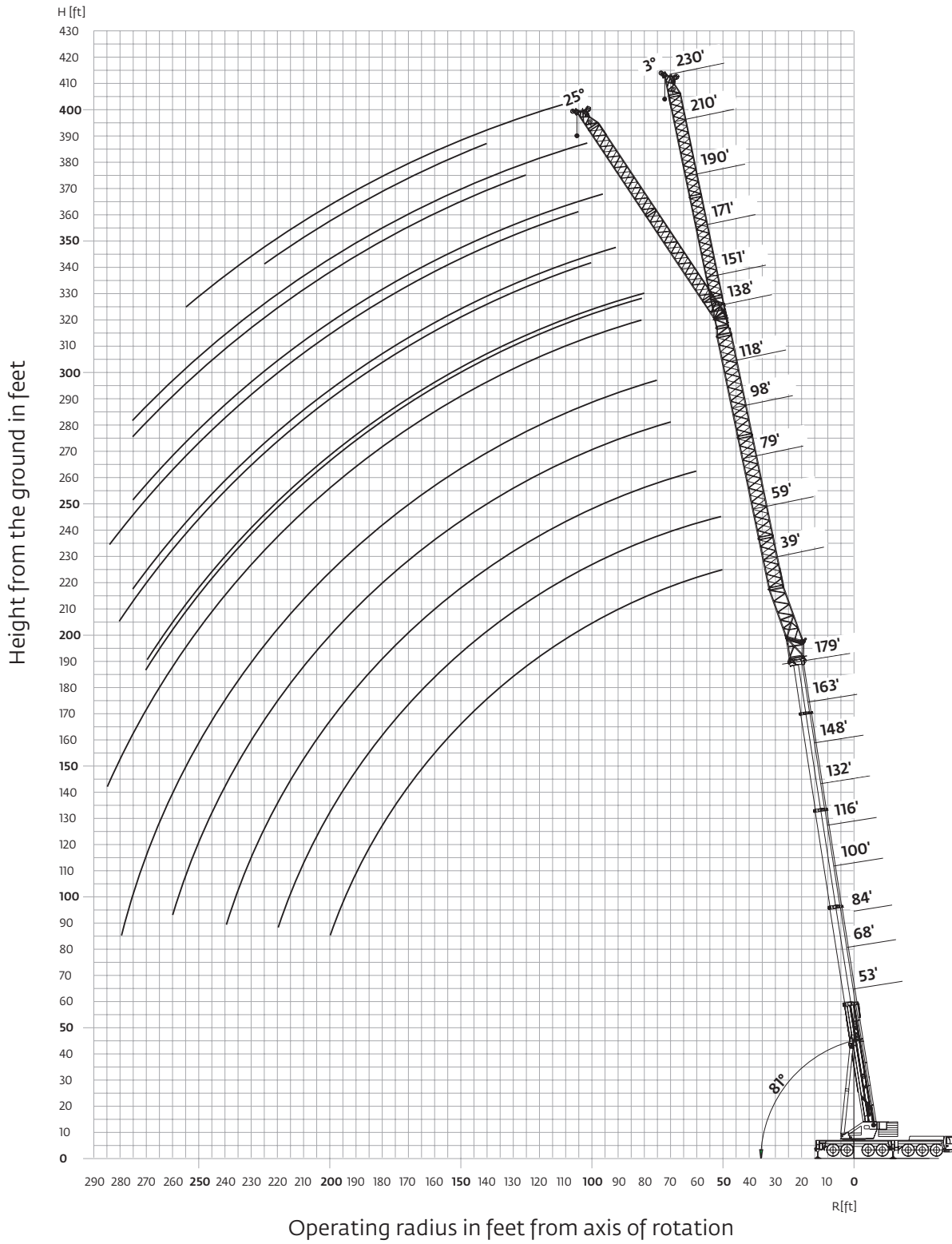

Hook heights shown in the working diagram do not consider loaded boom deflection.

Load chart

Lattice extension



Feet		Pounds (thousands)																					
Feet		163.4																					
Feet		39.4		59.1		78.7		98.4		118.1		137.8		150.9		170.6		190.3		210.0		229.7	
Feet		3°		3°		3°		3°		3°		3°		3° 25°		3° 25°		3° 25°		3° 25°		3° 25°	
45	105.0																						
50	100.0		87.0																				
55	96.0		83.0		66.0																		
60	90.0		80.0		63.0		51.0																
65	85.0		77.0		61.0		49.0																
70	79.0		72.0		58.0		47.0		41.6														
75	74.0		68.0		56.0		45.0		40.0		33.8		28.2										
80	70.0		64.0		53.0		43.6		38.6		32.6		27.0	25.6	23.4								
85	66.0		61.0		51.0		42.0		37.2		31.4		26.0	24.4	22.6								
90	62.0		57.0		50.0		40.4		35.8		29.8		24.8	23.6	21.6		19.0						
95	58.0		54.0		48.0		39.0		34.4		28.4		23.8	22.6	20.8	18.6	18.2		15.4		13.0		
100	54.0		51.0		46.0		37.8		33.4		26.8		23.0	21.8	19.8	17.8	17.4	15.0	14.8		12.6	10.4	12.4
105	52.0		49.0		45.0		36.6		32.2		25.8		22.0	21.0	19.2	17.2	16.8	14.4	14.2		12.0		12.0
110	49.0		46.0		43.0		35.2		31.2		25.0		21.2	20.2	18.4	16.4	16.0	13.8	13.6		11.4		11.4
115	46.0		44.0		41.4		34.0		30.0		24.2		20.4	19.4	17.6	15.8	15.4	13.2	13.2		11.0		11.0
120	43.6		41.8		39.6		32.8		28.8		23.4		19.6	18.8	17.0	15.2	14.8	12.8	12.6		10.4		10.6
125	41.0		39.8		37.8		31.6		27.6		22.4		18.8	18.0	16.2	14.6	14.2	12.2	12.0		10.0		10.2
130	38.6		38.0		36.0		30.4		26.4		21.8		18.2	17.4	15.6	14.2	13.6	11.8	11.6		9.6		9.6
135	36.6		36.0		34.2		29.2		25.2		21.2		17.6	16.8	15.0	13.6	13.0	11.2	11.0		9.0		9.2 7.4
140	34.6		34.2		32.6		28.0		24.2		20.4		17.0	16.2	14.4	13.2	12.4	10.8	10.6		8.6		8.8 7.0
145	32.6		32.4		30.8		26.8		23.6		19.8		16.4	15.6	14.0	12.6	12.0	10.4	10.2		8.4		8.4 6.6
150	30.6		30.6		29.0		25.8		23.0		19.2		15.8	15.2	13.4	12.2	11.6	10.0	9.6		8.0		8.2 6.4
155	28.6		29.0		27.4		25.0		22.4		18.6		15.2	14.6	13.0	11.8	11.0	9.6	9.2		7.6		7.8 6.0
160	26.6		27.4		25.6		24.0		21.6		18.2		14.8	14.0	12.4	11.4	10.6	9.2	8.8		7.2		7.4 5.8
165	25.0		26.0		24.4		23.2		21.0		17.6		14.2	13.6	12.0	11.0	10.2	8.8	8.4		7.0		7.0 5.4
170	23.0		24.4		23.4		22.2		20.4		17.2		13.8	13.2	11.6	10.6	9.8	8.6	8.0		6.6		6.6 5.2
175	21.2		22.8		22.4		21.2		19.8		16.6		13.4	12.8	11.2	10.2	9.4	8.2	7.8		6.4		6.4 4.8
180	19.4		21.2		21.4		20.4		19.2		16.2		12.8	12.4	10.8	9.8	9.0	8.0	7.4		6.0		6.0 4.6
185	17.8		19.6		20.2		19.6		18.4		15.8		12.4	12.0	10.4	9.6	8.6	7.6	7.0		5.8		5.6 4.4
190	16.4		18.0		19.2		18.6		17.8		15.4		12.0	11.6	10.0	9.2	8.4	7.2	6.8		5.6		5.4 4.0
195			16.4		18.2		17.8		17.2		15.0		11.6	11.2	9.6	8.8	8.0	7.0	6.4		5.2		5.2 3.8
200			15.0		16.8		17.0		16.6		14.6		11.4	11.0	9.2	8.6	7.8	6.8	6.0		5.0		4.8 3.6
205			13.8		15.4		16.0		15.8		14.2		11.0	10.6	9.0	8.2	7.4	6.6	5.8		4.8		4.6 3.4
210					14.2		15.2		15.0		13.8		10.6	10.2	8.6	8.0	7.2	6.2	5.6		4.6		4.2 3.2
215					12.8		13.8		14.4		13.4		10.2	10.0	8.4	7.8	6.8	6.0	5.4		4.4		4.0 3.0
220					11.8		12.6		13.6		12.8		10.0	9.6	8.0	7.4	6.6	5.8	5.0		4.2		3.8 2.8
225					10.6		11.6		12.4		12.2		9.6	9.2	7.8	7.2	6.2	5.6	4.8		4.0		3.6 2.6
230							10.4		11.4		11.6		9.0	8.8	7.4	7.0	6.0	5.4	4.6		3.8		3.4
235							9.4		10.4		10.6		8.6	8.4	7.2	6.8	5.8	5.2	4.2		3.6		3.2
240							8.4		9.4		9.6		7.6	8.0	6.8	6.4	5.6	5.0	4.0		3.4		3.0
245									8.4		8.6		6.8	7.2	6.6	6.2	5.4	4.8	3.8		3.2		2.8
250									7.4		7.8		5.8	6.2	6.2	6.0	5.2	4.6	3.6		3.0		3.0
255									6.6		7.0		5.0	5.2	5.6	5.8	4.8	4.4	3.4		2.8		2.8
260									5.8		6.0		4.0	4.4	4.8	5.4	4.6	4.2	3.4		2.6		2.6
265											5.2		3.2	3.6	4.0	4.8	4.4	3.8	3.2		2.6		2.6
270											4.4		2.6	2.8	3.2	4.0	3.8	3.6	3.0				3.0
275											3.8				2.4	3.2	3.0	3.4	2.8				2.8
280											3.0					2.4	2.2	3.2	2.4				2.4
285																		2.6					2.6

THIS CHART IS ONLY A GUIDE AND SHOULD NOT BE USED TO OPERATE THE CRANE.

The individual crane's load chart, operating instructions and other instructional plates must be read and understood prior to operating the crane.

Load chart

Lattice extension



Pounds (thousands)

Feet	179.2															
Feet	39.4	59.1	78.7	98.4	118.1	137.8	150.9		170.6		190.3		210.0		229.7	
	3°	3°	3°	3°	3°	3°	3°	25°	3°	25°	3°	25°	3°	25°	3°	25°
45																
50	87.0	78.0														
55	83.0	75.0														
60	80.0	72.0	60.0													
65	76.0	68.0	58.0													
70	72.0	65.0	56.0	47.0												
75	68.0	61.0	54.0	46.0	38.6											
80	65.0	58.0	52.0	44.0	37.4	31.4	25.8	24.6								
85	61.0	55.0	49.0	43.0	36.2	29.8	25.0	23.8								
90	57.0	52.0	47.0	41.6	35.0	28.2	24.2	22.8	20.8							
95	54.0	50.0	45.0	40.2	34.0	27.0	23.2	22.0	20.0	17.2						
100	51.0	47.0	43.4	38.8	32.8	26.2	22.4	21.2	19.4	17.4	16.6			13.8		11.6
105	49.0	45.0	41.6	37.4	31.4	25.4	21.6	20.6	18.6	16.8	16.0	14.0		13.4		11.2
110	46.0	43.0	39.8	35.8	30.2	24.6	20.8	19.8	18.0	16.2	15.6	13.4		13.0		10.8
115	44.0	41.0	38.0	34.6	28.8	24.0	20.2	19.2	17.2	15.6	15.0	13.0		12.4		10.4
120	41.8	39.2	36.4	33.2	27.6	23.2	19.4	18.6	16.6	15.0	14.4	12.4		12.0		10.0
125	39.8	37.2	35.0	31.8	26.6	22.6	18.8	18.0	16.0	14.6	14.0	12.0		11.6	9.8	9.6
130	37.8	35.4	33.6	30.6	25.8	21.8	18.2	17.4	15.4	14.0	13.4	11.6		11.2	9.4	9.2
135	35.8	33.6	32.2	29.2	25.0	21.2	17.6	16.8	15.0	13.6	13.0	11.2		10.8	9.0	8.8
140	34.0	31.8	30.6	27.8	24.2	20.6	17.0	16.2	14.4	13.0	12.4	10.8		10.4	8.6	8.4
145	32.0	30.0	29.2	26.6	23.4	20.0	16.4	15.6	14.0	12.6	12.0	10.4		10.0	8.2	8.2
150	30.4	28.2	28.0	25.2	22.6	19.4	16.0	15.2	13.4	12.2	11.4	10.0		9.6	7.8	7.8
155	28.8	26.4	26.6	23.8	21.8	18.8	15.4	14.8	13.0	11.8	11.0	9.6		9.2	7.6	7.4
160	27.2	25.0	25.2	22.6	21.0	18.2	14.8	14.2	12.4	11.4	10.6	9.2		8.8	7.2	7.2
165	25.6	24.0	23.8	21.6	20.2	17.6	14.4	13.8	12.0	11.0	10.2	9.0		8.4	7.0	6.8
170	24.0	22.8	22.4	20.8	19.4	17.2	13.8	13.4	11.6	10.6	9.8	8.6		8.2	6.6	6.6
175	22.2	21.8	21.2	20.0	18.6	16.6	13.4	13.0	11.2	10.2	9.6	8.2		7.8	6.4	6.2
180	21.0	20.8	20.4	19.2	17.8	16.0	13.0	12.6	10.8	10.0	9.2	8.0		7.4	6.0	6.0
185	19.2	19.6	19.4	18.4	17.2	15.4	12.6	12.2	10.4	9.6	8.8	7.6		7.2	5.8	5.8
190	17.6	18.6	18.6	17.4	16.6	14.8	12.0	11.8	10.2	9.4	8.4	7.4		6.8	5.6	5.4
195	16.2	17.2	17.6	16.6	15.8	14.4	11.6	11.4	9.8	9.0	8.2	7.2		6.6	5.4	5.2
200	14.8	15.8	16.8	16.0	15.2	13.8	11.2	11.0	9.4	8.8	7.8	6.8		6.2	5.2	5.0
205		14.4	15.8	15.2	14.6	13.2	10.6	10.6	9.2	8.4	7.6	6.6		6.0	4.8	4.6
210		13.2	14.6	14.6	13.8	12.8	10.2	10.2	8.8	8.2	7.4	6.4		5.6	4.6	4.4
215		12.0	13.4	13.8	13.2	12.2	9.8	9.8	8.4	7.8	7.0	6.2		5.4	4.4	4.2
220		10.8	12.2	13.0	12.8	11.6	9.2	9.2	8.2	7.6	6.8	6.0		5.2	4.2	4.0
225			11.2	12.0	12.2	11.2	8.8	8.8	7.8	7.4	6.6	5.8		5.0	4.0	3.6
230			10.0	10.8	11.6	10.6	8.4	8.4	7.4	7.0	6.2	5.4		4.8	3.8	3.4
235			9.0	9.8	10.6	10.2	7.8	8.0	7.0	6.8	6.0	5.2		4.6	3.6	3.2
240			8.2	8.8	9.6	9.6	7.4	7.6	6.6	6.4	5.6	5.0		4.2	3.4	3.0
245				7.8	8.6	8.8	6.8	7.2	6.2	6.2	5.4	4.8		4.0	3.2	2.8
250				7.0	7.8	7.8	5.8	6.2	5.8	5.8	5.0	4.6		3.8	3.2	2.6
255				6.0	6.8	7.0	5.0	5.4	5.4	5.6	4.8	4.6		3.6	3.0	2.4
260				5.2	6.0	6.2	4.2	4.4	4.8	5.2	4.4	4.4		3.2	2.8	
265					5.2	5.4	3.4	3.6	4.0	4.8	4.0	4.2		3.0	2.6	
270					4.4	4.6	2.6	2.8	3.2	4.0	3.6	3.8		2.8	2.6	
275					3.8	3.8			2.4	3.2	2.8	3.6		2.6	2.4	
280					3.0	3.2				2.4		3.2				
285						2.4						2.6				

THIS CHART IS ONLY A GUIDE AND SHOULD NOT BE USED TO OPERATE THE CRANE.
The individual crane's load chart, operating instructions and other instructional plates must be read and understood prior to operating the crane.

Working range

Lattice extension

53 ft - 131 ft boom extension

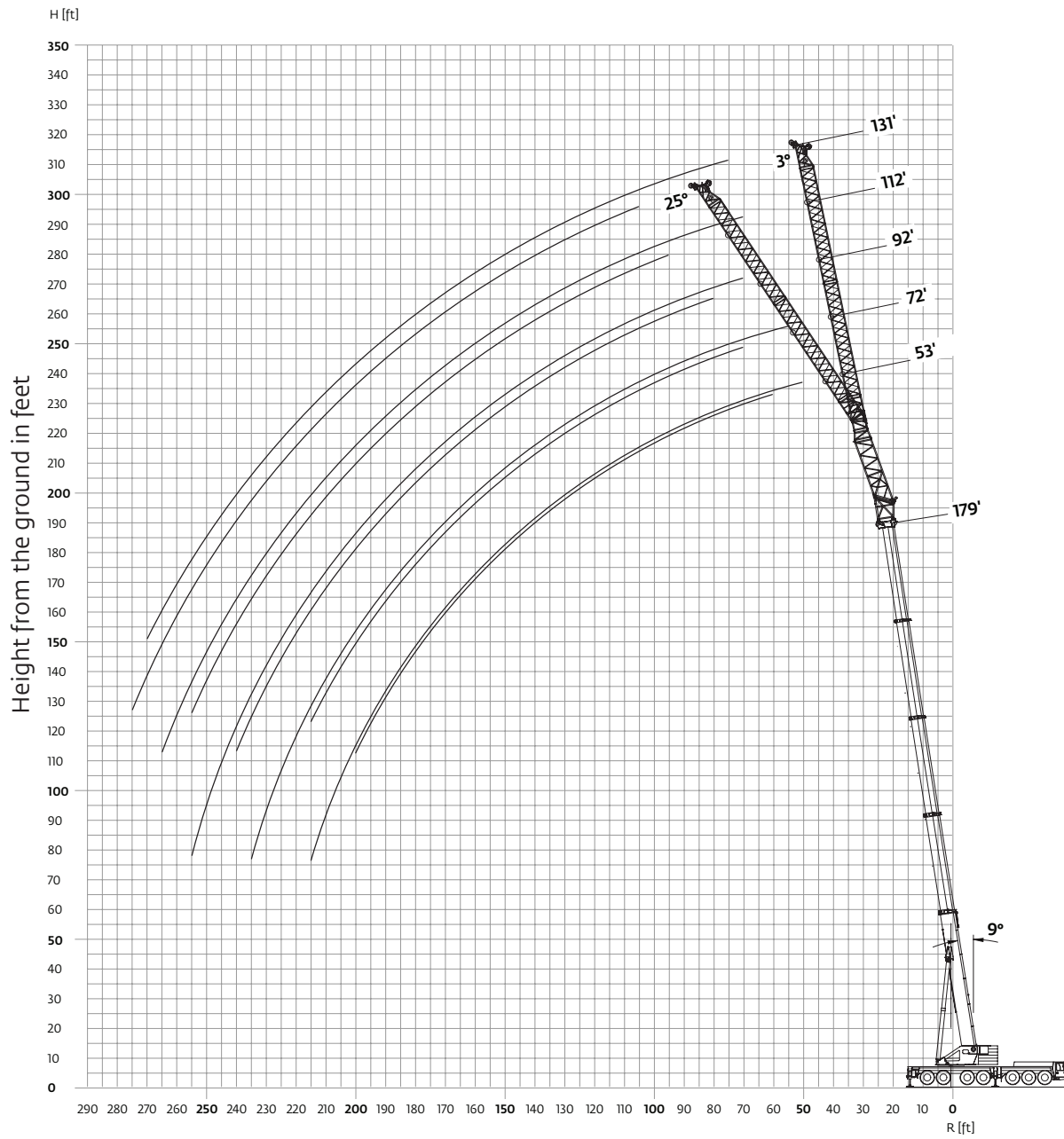

Operating radius in feet from axis of rotation

Hook heights shown in the working diagram do not consider loaded boom deflection.

Load chart

Lattice extension

 49.8 m
(163.4 ft)
  16 m - 60 m
(53 ft - 131 ft)
  120 000 kg
(264,500 lb)
  29 ft 2 in spread
(100%)
  360°

 Pounds (thousands)

Feet	52.5		72.2		163.4		111.6		131.2	
	3°	25°	3°	25°	3°	25°	3°	25°	3°	25°
45	97.0									
50	94.0		74.0							
55	88.0	79.0	71.0							
60	82.0	77.0	69.0		54.0		43.2			
65	78.0	74.0	66.0		52.0		41.6			
70	73.0	71.0	63.0	51.0	50.0		40.0		34.6	
75	69.0	67.0	61.0	49.0	48.0		38.4		33.2	
80	65.0	64.0	58.0	48.0	47.0	36.4	37.0		32.0	
85	61.0	60.0	55.0	46.0	45.0	35.4	35.6		30.6	
90	57.0	57.0	53.0	45.0	43.4	34.4	34.4	25.0	29.0	
95	54.0	53.0	50.0	43.8	42.0	33.4	34.4	24.4	27.4	
100	51.0	51.0	48.0	42.8	40.6	32.6	33.2	23.8	26.0	19.8
105	48.0	48.0	45.0	41.6	39.2	31.6	32.2	23.2	25.2	19.2
110	46.0	46.0	43.4	40.4	38.0	30.6	31.0	22.6	24.4	18.8
115	43.2	43.4	41.4	39.0	36.6	29.4	29.8	22.0	23.6	18.2
120	41.2	41.2	39.4	37.8	35.4	28.2	28.6	21.4	22.8	17.8
125	39.0	39.2	37.4	36.4	34.2	27.0	27.4	21.0	22.2	17.4
130	37.0	37.2	35.4	35.2	33.0	26.6	26.2	20.4	21.4	17.0
135	35.0	35.2	33.4	33.6	31.8	26.0	25.2	20.0	20.8	16.6
140	32.8	33.4	31.6	31.8	30.6	25.4	24.4	19.6	20.2	16.2
145	31.2	31.4	29.6	30.0	29.2	24.8	23.8	19.2	19.6	15.8
150	29.4	29.8	27.8	28.2	27.6	24.2	23.0	18.8	19.0	15.4
155	27.8	28.0	26.0	26.4	26.2	23.6	22.4	18.4	18.6	15.0
160	26.0	26.4	24.4	25.0	24.8	23.0	21.8	18.0	18.0	14.8
165	24.4	24.8	23.4	23.8	23.2	22.4	21.2	17.6	17.6	14.4
170	22.6	23.2	22.2	22.8	21.8	21.8	20.6	17.4	17.0	14.2
175	20.6	21.2	21.2	21.6	20.8	21.2	19.8	17.0	16.6	13.8
180	18.8	19.4	20.0	20.4	19.8	20.4	19.2	16.8	16.2	13.6
185	17.2	17.6	19.0	19.4	19.0	19.6	18.6	16.4	15.8	13.4
190	15.6	16.0	17.4	18.2	18.0	18.6	17.8	16.2	15.4	13.2
195	14.0		15.8	17.0	17.0	17.6	17.2	15.6	15.0	13.0
200	12.6		14.4	15.4	16.0	16.8	16.4	15.2	14.6	12.6
205			13.0		14.6	15.8	15.8	14.8	14.2	12.4
210			11.8		13.2	15.0	15.0	14.2	13.8	12.2
215			10.6		12.0	13.6	14.2	13.8	13.2	12.0
220			9.4		10.8	12.2	13.2	13.2	12.4	11.6
225					9.8		12.0	12.8	11.8	11.4
230					8.8		11.0	11.6	10.8	11.2
235					7.8		9.8	10.4	9.8	11.0
240					6.8		8.8	9.2	8.8	10.6
245							7.8		7.8	10.2
250							6.8		6.8	9.0
255							6.0		6.0	7.8
260							5.0		5.2	6.8
265							4.2		4.4	
270									3.6	

THIS CHART IS ONLY A GUIDE AND SHOULD NOT BE USED TO OPERATE THE CRANE.

Load chart

Lattice extension

 54,6 m
(179.2 ft)
  16 m - 40 m
(53 ft - 131 ft)
  120 000 kg
(264,500 lb)
  29 ft 2 in spread
(100%)
  360°

  Pounds (thousands)

Feet	52.5		72.2		91.9		111.6		131.2	
Feet	3°	25°	3°	25°	3°	25°	3°	25°	3°	25°
45										
50	81.0									
55	77.0		67.0							
60	73.0	71.0	65.0							
65	70.0	67.0	61.0							
70	66.0	64.0	58.0	50.0	49.0					
75	63.0	61.0	55.0	48.0	47.0		40.4			32.2
80	59.0	57.0	53.0	47.0	46.0	36.0				30.8
85	56.0	54.0	50.0	46.0	44.0	35.0				29.0
90	53.0	52.0	48.0	44.0	42.6	34.2				27.6
95	50.0	49.0	46.0	43.0	41.2	33.2				26.6
100	47.0	47.0	43.6	41.6	39.6	32.4	34.4	25.6		25.8
105	45.0	45.0	41.6	40.0	38.0	31.6	32.4	24.4		25.0
110	43.0	42.6	39.6	38.4	36.4	30.8	32.4	23.8		24.2
115	40.8	40.6	38.0	36.8	34.8	30.0	31.6	23.2		23.4
120	38.8	38.6	36.4	35.2	33.2	29.0	30.6	22.8		22.8
125	36.6	36.8	34.8	33.4	31.8	28.0	29.4	22.2		22.0
130	34.6	34.8	33.0	31.6	30.2	27.0	28.2	21.8		21.4
135	32.8	32.8	31.4	29.8	28.6	26.0	26.8	21.4		20.8
140	30.8	31.0	29.8	28.2	27.2	25.2	25.6	21.0		20.4
145	28.8	29.0	28.4	27.0	25.6	24.4	24.2	20.8		20.0
150	27.0	27.2	26.8	25.8	24.4	23.6	23.2	20.4		19.8
155	25.2	25.4	25.4	24.8	23.4	23.0	22.4	20.0		19.2
160	24.0	24.2	23.8	23.6	22.4	22.2	21.6	19.8		18.6
165	22.8	23.2	22.4	22.6	21.4	21.4	20.8	19.4		18.2
170	21.8	22.0	21.2	21.6	20.6	20.6	20.2	19.0		17.6
175	20.6	20.8	20.2	20.6	19.6	19.8	19.4	18.6		17.0
180	19.4	19.6	19.2	19.6	18.6	18.8	18.4	18.0		16.6
185	18.0	18.4	18.2	18.6	17.8	18.0	17.6	17.4		16.2
190	16.4	17.0	17.4	17.8	17.0	17.4	16.8	16.8		15.6
195	15.0	15.4	16.4	16.8	16.2	16.6	16.2	16.2		15.0
200	13.6	14.0	15.0	15.8	15.4	15.8	15.4	15.6		14.4
205	12.2		13.8	15.0	14.6	15.0	14.6	15.0		13.8
210	11.0		12.4	13.6	13.8	14.4	14.0	14.4		13.2
215	9.8		11.2	12.2	12.8	13.6	13.2	13.8		12.6
220			10.0		11.6	12.8	12.6	13.2		12.0
225			9.0		10.4	11.8	12.0	12.6		11.4
230			7.8		9.4	10.6	11.2	12.0		10.8
235			6.8		8.4	9.4	10.0	11.4		10.4
240					7.4	8.2	9.0	10.8		9.8
245					6.4		8.0	9.8		8.8
250					5.4		7.2	8.6		7.8
255					4.6		6.2	7.6		7.0
260							5.4	6.6		6.0
265							4.6			5.2
270							3.8			4.4
275										3.6
										4.4

Working range

Lattice extension with MegaWingLift™



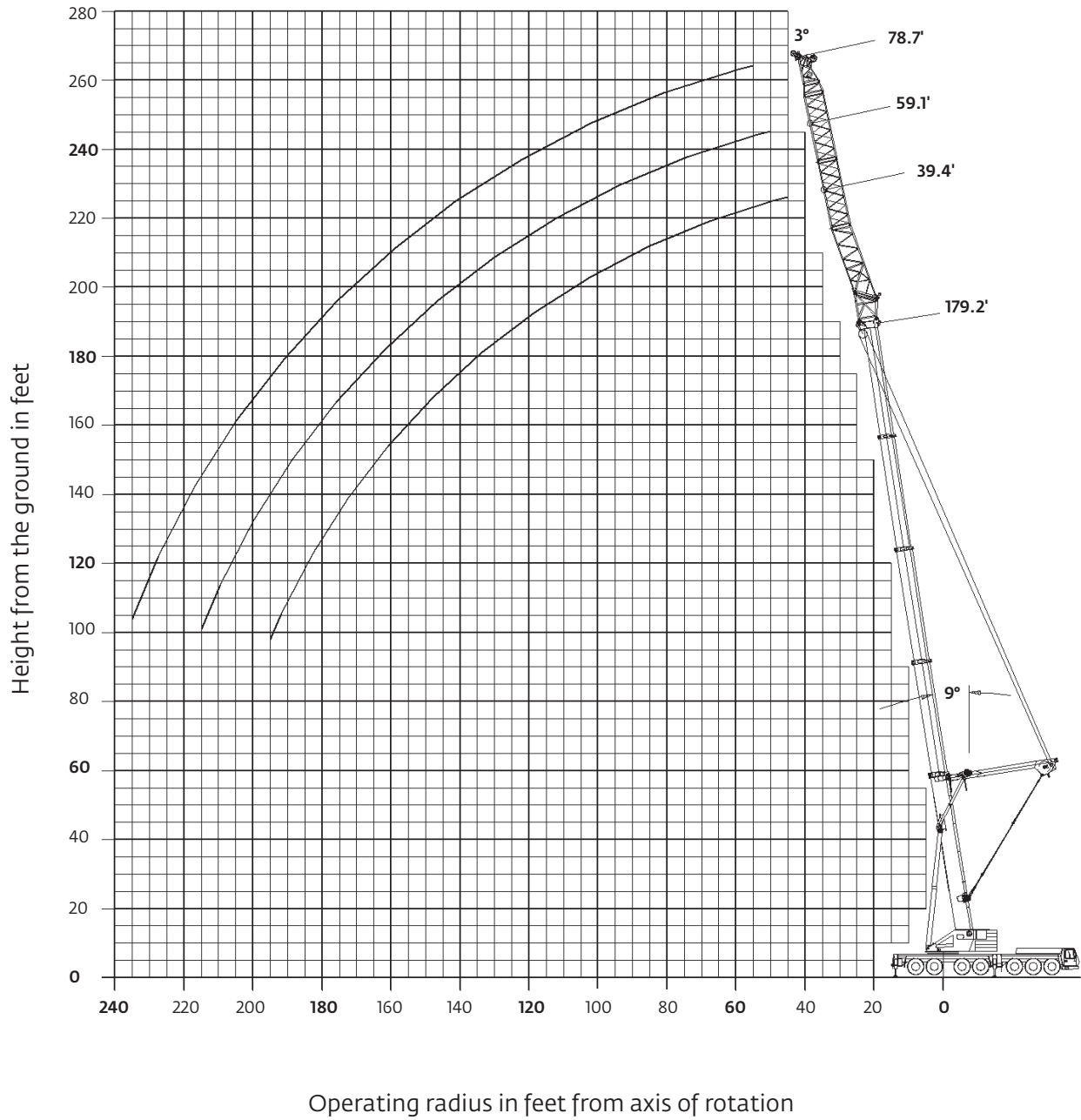

39 ft - 79 ft lattice extension with MegaWingLift



Hook heights shown in the working diagram do not consider loaded boom deflection.

Load chart

Lattice extension with MegaWingLift™

 49,8 m - 54,6 m
(163.4 ft - 179.2 ft)
  12 m - 24 m
(39 ft - 79 ft)
  160 000 kg
(352,700 lb)
  29 ft 2 in spread
(100%)
  360°

		Pounds (thousands)					
Feet	163.4				179.2		
Feet	39.4	59.1	78.7	39.4	59.1	78.7	
	3°	3°	3°	3°	3°	3°	
40	114.0						
45	107.0	86.0		100.0			
50	100.0	81.0	66.0	94.0	78.0		
55	95.0	77.0	63.0	88.0	74.0	62.0	
60	90.0	73.0	61.0	83.0	69.0	59.0	
65	85.0	69.0	58.0	79.0	65.0	56.0	
70	81.0	65.0	55.0	74.0	62.0	52.0	
75	77.0	62.0	52.0	71.0	58.0	50.0	
80	73.0	59.0	49.0	68.0	55.0	48.0	
85	69.0	56.0	47.0	65.0	52.0	45.0	
90	67.0	53.0	45.0	62.0	50.0	43.2	
95	64.0	51.0	43.2	59.0	48.0	41.4	
100	62.0	49.0	41.4	56.0	46.0	39.8	
105	59.0	47.0	39.4	54.0	43.8	38.2	
110	57.0	45.0	38.0	52.0	42.2	36.6	
115	55.0	43.4	36.8	49.0	40.8	35.0	
120	53.0	41.8	35.4	47.0	39.4	33.6	
125	51.0	40.2	34.2	46.0	37.8	32.2	
130	49.0	39.0	32.8	44.0	36.4	30.8	
135	47.0	37.8	31.4	43.0	35.0	29.4	
140	46.0	36.6	30.4	41.6	33.8	28.0	
145	45.0	35.4	29.2	40.2	32.4	26.6	
150	43.4	34.2	28.0	38.8	31.2	25.8	
155	40.8	33.2	27.0	37.8	29.8	25.0	
160	38.2	32.4	25.8	36.8	28.6	24.2	
165	35.6	31.4	24.6	35.8	27.4	23.6	
170	33.4	30.6	23.8	34.4	26.6	22.8	
175	31.2	29.8	23.2	32.2	26.0	22.0	
180	29.2	28.8	22.6	30.2	25.2	21.4	
185		28.0	22.0	28.2	24.6	20.8	
190		27.0	21.4	26.4	23.8	20.2	
195		25.4	20.8	24.6	23.2	19.6	
200		23.6	20.2		22.8	19.2	
205			19.8		22.2	18.6	
210			19.4		21.2	18.0	
215			19.0		19.8	17.6	
220			18.4			17.2	
225						16.8	
230						16.4	
235						16.0	

Working range

Heavy duty jib

13 ft heavy duty jib

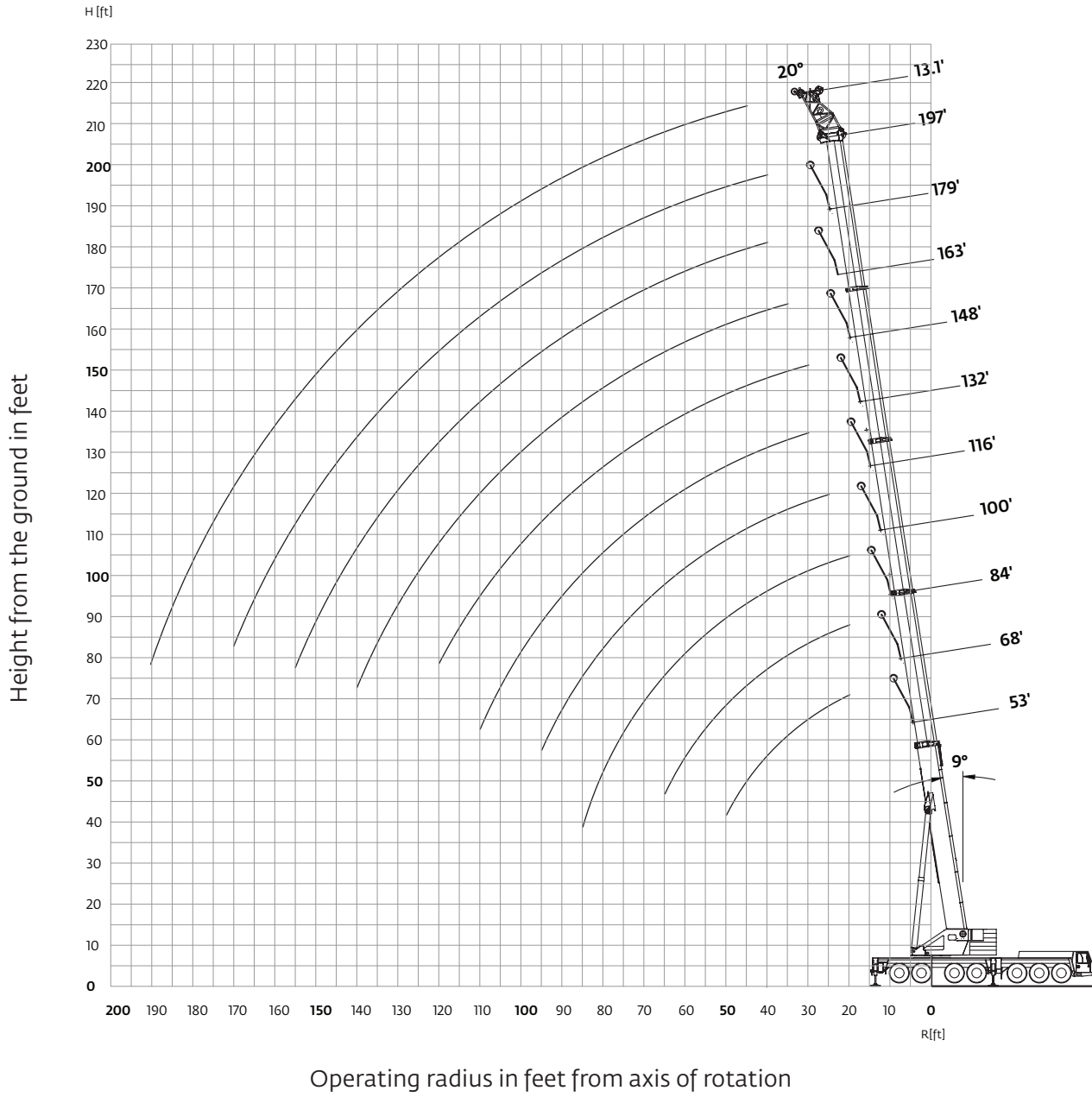

Load chart

Heavy duty jib

 16.0 m - 60 m
(53 ft - 197 ft)
  4 m
(13.1 ft)
  120 000 kg
(264,500 lb)
  29 ft 2 in spread
(100%)
  360°

Feet	Pounds (thousands)									
	52.6	68.4	84.3	100.1	115.9	131.7	147.6	163.4	179.2	196.9
20	190.0	190.0	190.0							
25	190.0	190.0	190.0	190.0						
30	190.0	190.0	190.0	190.0	190.0	190.0				
35	190.0	190.0	190.0	190.0	190.0	182.0	166.0			
40	190.0	190.0	190.0	190.0	181.0	167.0	153.0	138.0	120.0	
45	190.0	190.0	190.0	185.0	164.0	151.0	140.0	129.0	116.0	104.0
50	190.0	190.0	187.0	170.0	151.0	140.0	130.0	121.0	109.0	99.0
55		171.0	169.0	156.0	138.0	129.0	120.0	113.0	102.0	94.0
60		154.0	151.0	143.0	128.0	118.0	110.0	105.0	96.0	89.0
65		138.0	135.0	132.0	119.0	109.0	102.0	98.0	91.0	84.0
70			120.0	121.0	110.0	102.0	95.0	91.0	85.0	79.0
75			107.0	108.0	103.0	95.0	88.0	85.0	80.0	74.0
80			96.0	97.0	97.0	88.0	82.0	79.0	75.0	71.0
85			86.0	88.0	88.0	83.0	77.0	74.0	71.0	67.0
90				79.0	80.0	78.0	73.0	70.0	67.0	63.0
95				72.0	73.0	74.0	68.0	66.0	63.0	60.0
100					66.0	68.0	64.0	62.0	60.0	56.0
105					60.0	62.0	61.0	58.0	57.0	53.0
110					55.0	57.0	58.0	55.0	54.0	49.0
115						52.0	54.0	52.0	51.0	47.0
120						48.0	50.0	49.0	48.0	45.0
125							46.0	47.0	45.0	42.6
130							42.2	45.0	43.4	40.4
135							39.0	41.2	41.4	38.2
140							36.0	38.2	39.4	36.2
145								35.4	37.4	34.4
150								32.8	34.8	32.8
155								30.4	32.4	31.0
160									30.2	29.2
165									28.0	27.4
170									26.2	25.6
175										24.4
180										22.6
185										21.0
190										19.4

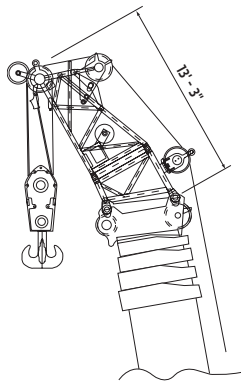

THIS CHART IS ONLY A GUIDE AND SHOULD NOT BE USED TO OPERATE THE CRANE.

The individual crane's load chart, operating instructions and other instructional plates must be read and understood prior to operating the crane.

Working range

Heavy duty jib

25 ft heavy duty jib

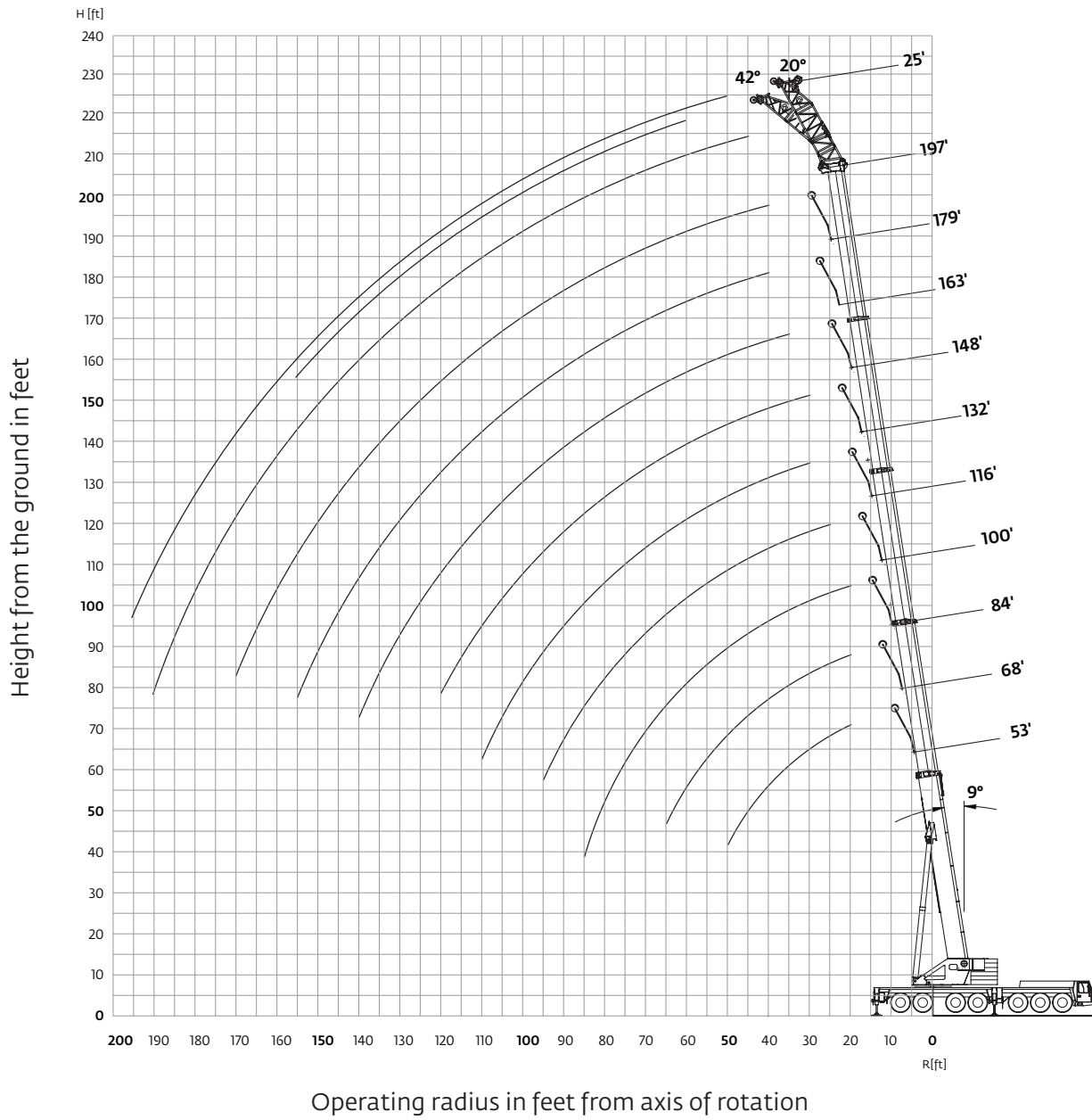

Hook heights shown in the working diagram do not consider loaded boom deflection.

Load chart

Heavy duty jib

 16.0 m - 60 m (53 ft - 197 ft)
  7.5 m (24.6 ft)
  120 000 kg (264,500 lb)
  29 ft 2 in spread (100%)
  360°

Feet	Pounds (thousands)																				
	52.6		68.4		84.3		100.1		115.9		131.7		147.6		163.4		179.2		196.9		
	20°	42°	20°	42°	20°	42°	20°	42°	20°	42°	20°	42°	20°	42°	20°	42°	20°	42°	20°	42°	
20	118.0		122.0																		
25	107.0	94.0	113.0	97.0	117.0																
30	100.0	89.0	106.0	93.0	110.0	95.0	114.0	96.0	115.0												
35	93.0	85.0	100.0	89.0	104.0	91.0	108.0	93.0	110.0	94.0	111.0										
40	88.0	81.0	94.0	85.0	99.0	88.0	103.0	90.0	105.0	91.0	107.0	92.0	106.0	92.0	104.0						
45	84.0	79.0	89.0	83.0	95.0	85.0	99.0	88.0	101.0	89.0	103.0	90.0	103.0	90.0	101.0			97.0			
50	79.0	77.0	85.0	80.0	91.0	83.0	95.0	85.0	98.0	87.0	100.0	88.0	100.0	87.0	99.0	87.0	95.0	84.0	88.0		
55	76.0		82.0	78.0	87.0	81.0	91.0	83.0	94.0	85.0	96.0	86.0	97.0	86.0	95.0	85.0	91.0	83.0	84.0		
60	75.0		79.0	77.0	83.0	79.0	88.0	81.0	91.0	83.0	93.0	84.0	94.0	84.0	91.0	83.0	87.0	82.0	80.0	78.0	72.0
65	74.0		76.0	76.0	81.0	78.0	85.0	80.0	88.0	81.0	91.0	82.0	92.0	83.0	87.0	82.0	83.0	80.0	76.0	75.0	
70			75.0		79.0	77.0	82.0	78.0	86.0	80.0	88.0	81.0	87.0	80.0	83.0	80.0	78.0	76.0	72.0	72.0	
75			75.0		76.0	76.0	80.0	78.0	83.0	79.0	85.0	80.0	82.0	78.0	79.0	78.0	73.0	72.0	68.0	68.0	
80					74.0		78.0	77.0	80.0	77.0	81.0	77.0	78.0	75.0	75.0	74.0	69.0	69.0	65.0	65.0	
85					74.0		76.0	76.0	78.0	75.0	77.0	74.0	73.0	73.0	70.0	70.0	66.0	65.0	61.0	61.0	
90						74.0		74.0	76.0		75.0	73.0	73.0	72.0	69.0	69.0	66.0	66.0	62.0	62.0	58.0
95								73.0			72.0	71.0	69.0	69.0	65.0	65.0	62.0	63.0	58.0	59.0	54.0
100											68.0	68.0	65.0	66.0	61.0	61.0	59.0	60.0	55.0	55.0	52.0
105											62.0	62.0	62.0	62.0	57.0	57.0	56.0	56.0	53.0	53.0	49.0
110											56.0	57.0	58.0	59.0	53.0	54.0	52.0	53.0	50.0	50.0	47.0
115												52.0	54.0	51.0	51.0	49.0	50.0	48.0	48.0	44.0	45.0
120												48.0	49.0	48.0	49.0	47.0	47.0	45.0	45.0	42.0	42.4
125													45.0	46.0	44.0	45.0	42.8	43.0	40.0	40.4	
130														41.4	42.8	42.2	42.4	40.4	40.8	38.2	38.6
135															38.0	39.4	40.2	40.2	38.4	39.0	36.2
140																36.4	38.0	36.4	37.2	34.4	34.8
145																	33.4	35.4	34.4	32.6	32.8
150																		30.6	32.8	30.8	31.0
155																			30.2	30.4	29.2
160																			27.8	28.4	27.6
165																				27.0	26.2
170																				25.2	24.6
175																				23.4	23.0
180																				21.6	21.4
185																					19.8
190																					18.2
195																					16.8

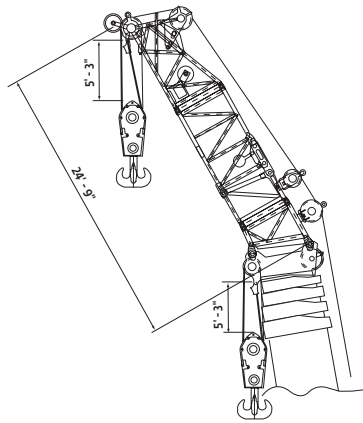

THIS CHART IS ONLY A GUIDE AND SHOULD NOT BE USED TO OPERATE THE CRANE.

The individual crane's load chart, operating instructions and other instructional plates must be read and understood prior to operating the crane.

Working range

Heavy duty jib with MegaWingLift™



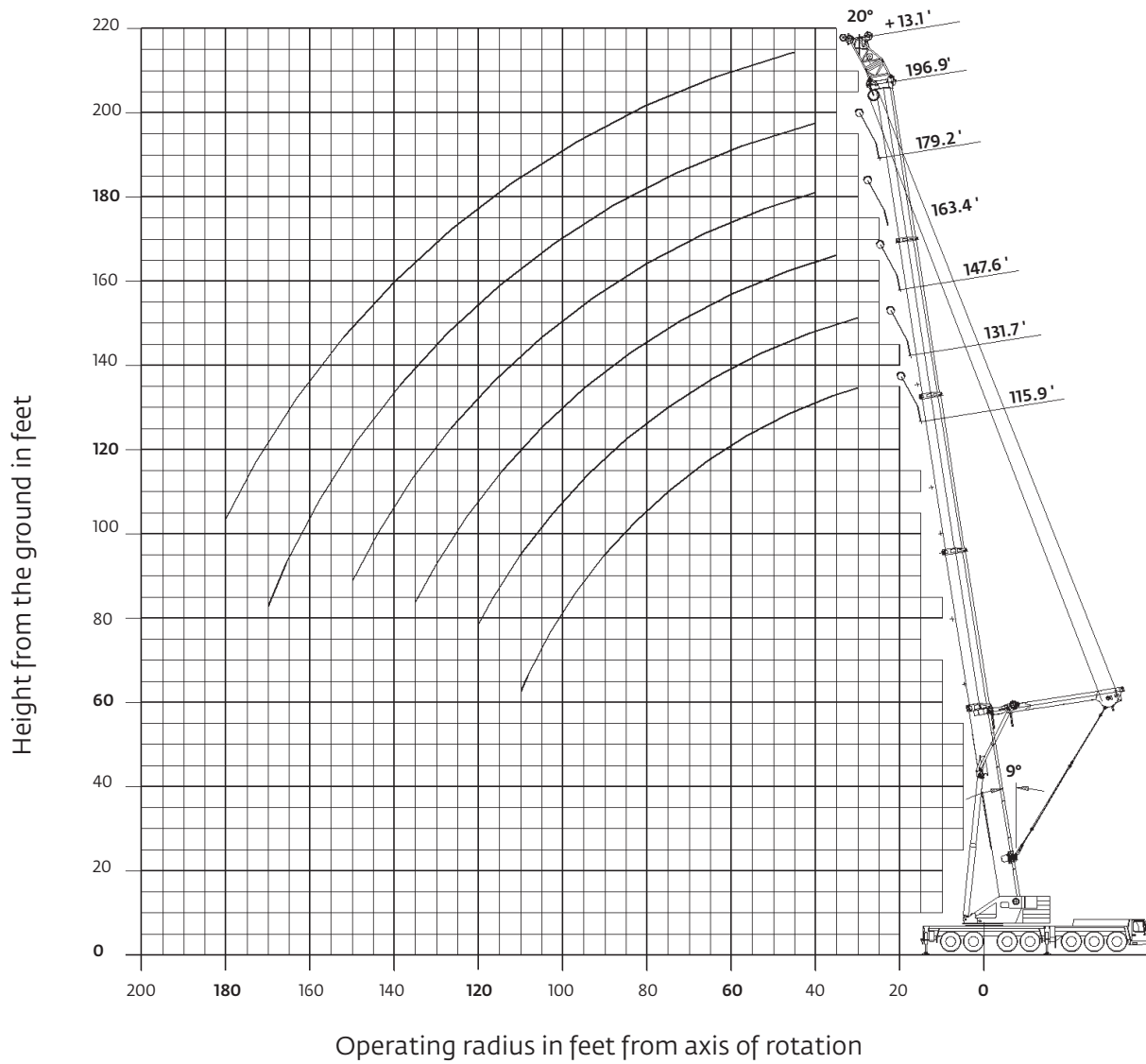



13 ft heavy duty jib with MegaWingLift



Hook heights shown in the working diagram do not consider loaded boom deflection.

Load chart

Heavy duty jib with MegaWingLift™

	 35,3 m - 60 m (116 ft - 197 ft)	 4 m (13.1 ft)	 160 000 kg (352,700 lb)	 29 ft 2 in spread (100%)	 360°	
	 Pounds (thousands)					
Feet	115.9	131.7	147.6	163.4	179.2	196.9
30	190.0	190.0				
35	190.0	190.0	190.0			
40	190.0	190.0	190.0	171.0	148.0	
45	190.0	190.0	190.0	162.0	139.0	128.0
50	187.0	186.0	188.0	154.0	132.0	121.0
55	173.0	175.0	175.0	146.0	125.0	115.0
60	157.0	159.0	165.0	140.0	119.0	109.0
65	143.0	145.0	155.0	134.0	113.0	104.0
70	131.0	133.0	145.0	128.0	108.0	99.0
75	120.0	123.0	134.0	122.0	103.0	95.0
80	110.0	113.0	123.0	115.0	99.0	91.0
85	102.0	104.0	113.0	106.0	95.0	88.0
90	94.0	97.0	104.0	99.0	91.0	84.0
95	88.0	90.0	97.0	92.0	87.0	81.0
100	81.0	84.0	90.0	86.0	84.0	78.0
105	76.0	78.0	84.0	80.0	81.0	76.0
110	69.0	73.0	78.0	75.0	76.0	73.0
115		68.0	73.0	70.0	72.0	70.0
120		63.0	68.0	66.0	67.0	68.0
125			59.0	61.0	63.0	63.0
130			55.0	57.0	59.0	59.0
135			51.0	54.0	55.0	56.0
140				50.0	52.0	52.0
145				47.0	49.0	49.0
150				44.0	46.0	46.0
155					43.0	43.2
160					40.6	40.6
165					38.2	38.2
170					35.2	36.0
175						33.8
180						31.8

Working range

Heavy duty jib with MegaWingLift™

25 ft heavy duty jib with MegaWingLift

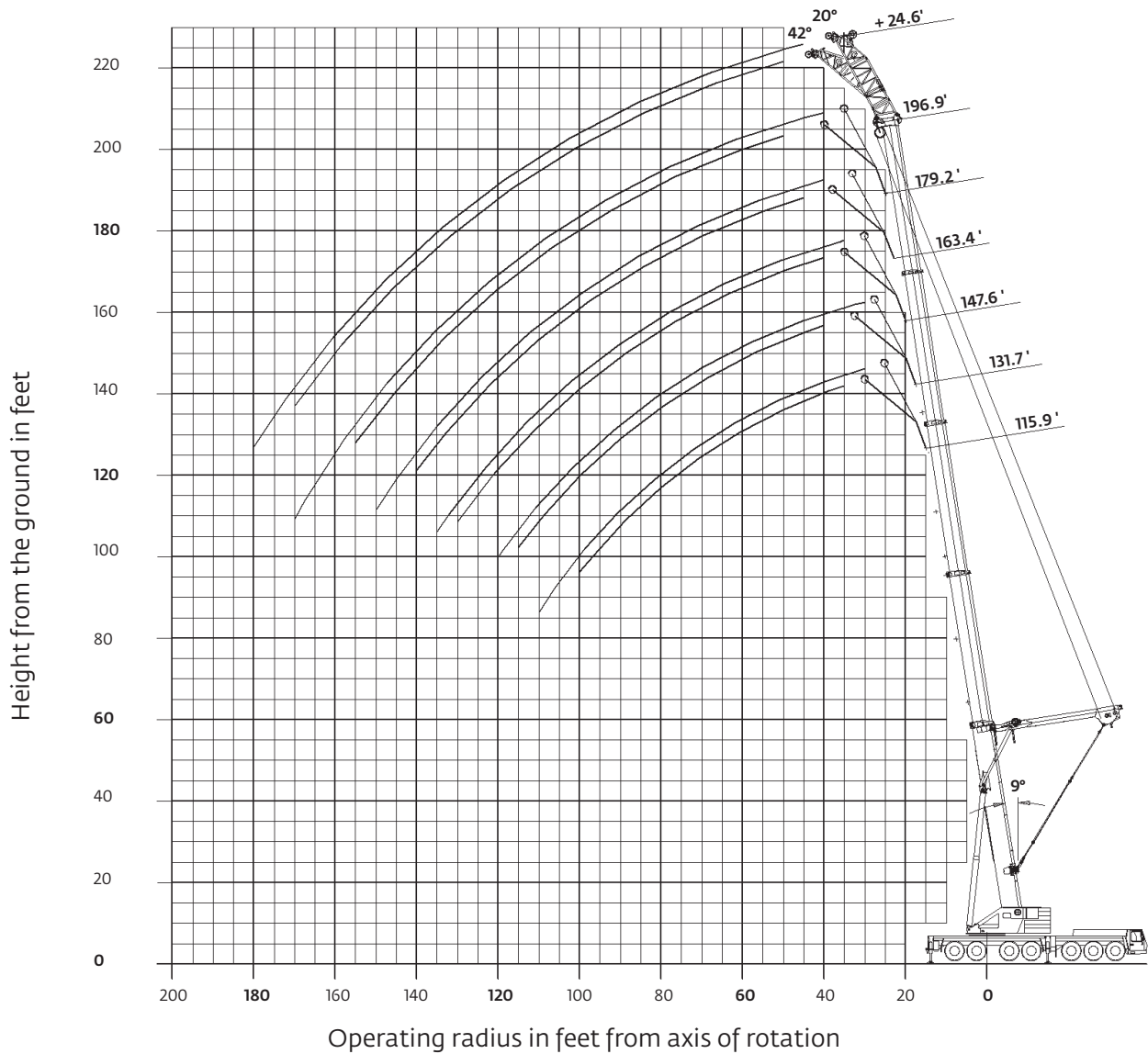

Hook heights shown in the working diagram do not consider loaded boom deflection.

































Load chart

Heavy duty jib with MegaWingLift™

 35,3 m - 60,0 m
(116 ft - 197 ft)
  7,5 m
(24.6 ft)
  160 000 kg
(352,700 lb)
  29 ft 2 in spread
(100%)
  360°

Feet	Pounds (thousands)											
	115.9		131.7		147.6		163.4		179.2		196.9	
	20°	42°	20°	42°	20°	42°	20°	42°	20°	42°	20°	42°
30	148.0		147.0									
35	140.0	114.0	140.0		138.0							
40	133.0	110.0	132.0	109.0	131.0	107.0	123.0		113.0			
45	126.0	106.0	126.0	105.0	125.0	104.0	117.0	100.0	108.0			
50	120.0	102.0	120.0	101.0	119.0	100.0	111.0	96.0	102.0	90.0	95.0	84.0
55	115.0	99.0	115.0	98.0	114.0	97.0	106.0	93.0	97.0	87.0	91.0	81.0
60	110.0	96.0	110.0	95.0	110.0	94.0	101.0	89.0	93.0	83.0	86.0	78.0
65	106.0	93.0	106.0	93.0	105.0	91.0	97.0	86.0	89.0	80.0	83.0	75.0
70	102.0	91.0	102.0	90.0	101.0	89.0	94.0	84.0	85.0	77.0	79.0	72.0
75	98.0	88.0	98.0	88.0	97.0	86.0	90.0	81.0	81.0	74.0	75.0	69.0
80	95.0	86.0	95.0	86.0	94.0	84.0	86.0	78.0	78.0	72.0	72.0	67.0
85	92.0	84.0	92.0	84.0	91.0	82.0	84.0	76.0	75.0	69.0	70.0	65.0
90	89.0	83.0	89.0	82.0	88.0	80.0	81.0	74.0	72.0	67.0	67.0	63.0
95	86.0	81.0	86.0	80.0	86.0	78.0	78.0	72.0	69.0	65.0	65.0	61.0
100	82.0	80.0	84.0	78.0	83.0	76.0	75.0	70.0	67.0	63.0	62.0	59.0
105	77.0		79.0	77.0	79.0	75.0	73.0	68.0	65.0	62.0	60.0	57.0
110	71.0		74.0	74.0	74.0	74.0	71.0	67.0	62.0	60.0	58.0	55.0
115	66.0		68.0	69.0	69.0	70.0	69.0	66.0	60.0	58.0	56.0	54.0
120	61.0		64.0		64.0	65.0	66.0	64.0	58.0	56.0	54.0	52.0
125			59.0		59.0	60.0	61.0	62.0	57.0	55.0	52.0	50.0
130			55.0		55.0	56.0	57.0	58.0	55.0	53.0	51.0	49.0
135			51.0		52.0		53.0	54.0	53.0	52.0	49.0	48.0
140					48.0		50.0	51.0	51.0	50.0	48.0	47.0
145					45.0		47.0		48.0	49.0	47.0	46.0
150					41.8		43.6		45.0	46.0	45.0	45.0
155							40.8		42.4	43.0	42.6	43.0
160							38.0		39.8		40.0	40.4
165									37.2		37.4	37.8
170									35.0		35.0	35.4
175									32.8		32.8	
180											30.8	
185											28.8	
190											27.0	
195											25.2	

Symbols glossary

 Axles	 Counterweight	 Grade	 Gear
 Boom	 Drive	 Heavy duty jib	 Radius
 Boom elevation	 Electrical system	 Hoist	 Rotation
 Boom extension	 Engine	 Hookblock	 Speed
 Boom length	 Extension	 Hydraulic system	 Steering
 Boom nose	 Frame	 Lights	 Suspension
 Brakes	 Fuel tank capacity	 Oil	 Swing
 Cab	 Outriggers	 Outrigger controls	 Tires
			 Transmission

Notes

Notes

Manitowoc Cranes

Regional headquarters

Americas

Manitowoc, Wisconsin, USA

Tel: +1 920 684 4410

Fax: +1 920 652 9778

Shady Grove, Pennsylvania, USA

Tel: +1 717 597 8121

Fax: +1 717 597 4062

Europe and Africa

Dardilly, France - TOWERS

Tel: +33 (0)4 72 18 20 20

Fax: +33 (0)4 72 18 20 00

Wilhelmshaven, Germany - MOBILE

Tel: +49 (0) 4421 294 0

Fax: +49 (0) 4421 294 4301

China

Shanghai, China

Tel: +86 21 6457 0066

Fax: +86 21 6457 4955

Middle East and Greater Asia-Pacific

Singapore

Tel: +65 6264 1188

Fax: +65 6862 4040

Dubai, UAE

Tel: +971 4 8862677

Fax: +971 4 8862678/79



Manitowoc
Crane Care™



Manitowoc
Finance™



This document is non-contractual. Constant improvement and engineering progress make it necessary that we reserve the right to make specification, equipment, and price changes without notice. Illustrations shown may include optional equipment and accessories and may not include all standard equipment.